



Genel Ürün Kataloğu
Catalaque For All Products
Каталог Продукции





MİSYONUMUZ

Dünya ve Türkiye için endüstriyel ütü makineleri imal etmek, ihracat rakamlarımızı yükselterek Dünya makine sektöründe ivme kazandırmaktır. Dünya tekstil sektörüne, kuru temizleme ve çamaşırhanelere dünya kalite standartlarında, uygun fiyatlı, Türk malı ütü makineleri ile katkıda bulunurken, firmamızı bir eğitim kurumu görüp ülkemize kalifiye insan gücü kazandırmak ve istihdam sağlamaktır.

VİZYONUMUZ

Kalitesi ve ürün çeşitliliği ile endüstriyel ütü sektöründe dünyanın öncü kuruluşları arasına yükselmek ve Malkan ismini bir dünya markası haline getirmektir.

- 1971 yılından gelen tecrübe
- Türkiyede ütü sektöründeki ilk firma
- 8600 m² kapalı üretim alanı
- 89 ülkeye ihracat
- Yıllık 15.000 makine üretim kapasitesi
- 20.000 m² yeni fabrika inşaatı
- 32.000 müşteri
- 130.000 çalışan makine sayısı
- Türkiye'de 48 noktada servis istasyonu
- Dünyada 26 noktada satış ve servis istasyonu
- 810 çeşit ürün
- Güçlü Ar-ge ekibi

KALİTE BELGELERİMİZ

- CE Tuv Avrupa Standartı
- ISO9001 Kalite Yönetim Sistemi
- TSE Uygunluk Belgesi
- TSEK Türk Standartları Enstitüsü Kalite Uygunluk Belgesi
- TSE Hizmet Yeterlilik Belgesi
- Yurt İçi Marka Tescil Belgesi
- Avrupa Topluluğu Marka Tescil Belgesi CTM
- Madrid Protokolü Marka Tescil Belgesi WIPO
- ISCIR (Romanya)
- GOST (Rusya)

OUR MISSION

Manufacturing industrial garment ironing machines, Accelerating World Machine Sector by increasing our export value. Adding value to World Textile, Laundry & Dry Cleaning Sectors by Turkish Ironing Machines with World Quality Standarts and Competitive Prices. Adding Qualified Manpower to Sector and Providing Employment

OUR VISION

Rising up through the world leading companies in Industrial Garment Ironing Sector and making Malkan a world brand

- Experience cumulated since 1971
- First company in Turkish Garment Ironing Sector
- 8600sqm closed factory area
- Export to 89 countries
- 15000 machines/year production capacity
- 20000 sqm new factory construction
- 32000 customers
- 130.000 working machine
- 48 service point in Turkey
- 26 sales & service point in the world
- 810 type products
- Powerful R&D team

QUALITY CERTIFICATIONS

- CE TUV European Standart
- ISO9001 Quality Management System
- TSE (Turkish Standarts Institution) Accordance Certification
- TSEK (Turkish Standarts Institution Quality) Accordance Certification
- TSE (Turkish Standarts Institution) Service Sufficiency Certification
- Domestic Brand Registration Certificate
- European Community Trademark Registration Certificate CTM
- Madrid Protocol Trademark Registration Certificate WIPO
- ISCIR (Romania)
- GOST (Russia)

НАША МИССИЯ

Производство промышленной гладильные машины, укоряя Миравая Текстильная Машина Сектора с увеличением нашего экспортного значения. Добовлять стоимости на Мировая Текстиля и Услуги Праченой и Химчистки секторах с Турецкий Гладильные Машины с Мировым Стандартам Качества. И Добовлять Квалифицированной Рабочей Силь в Секторе и Обеспечения Занятости

НАШ ВИЗЁН

Подниматься через ведущих мировых компаний в Промышленном Гладильные Машины Сектора и принят Малкан мировой Бренд

- Опыт с 1971 года
- Первая компания в Турции Гладильные секторе.
- 8600м закрытая площадь для производства
- Экспортируем 89 различных стран
- Годовой производительностью 15000 машин.
- 32.000 клиенты
- 130.000 рабочая машина
- 48 пункт обслуживания станции в Турции
- Продажа и обслуживания станций в 26 точках мира
- 810 различных продукции
- Е.Р.сильная команда

СЕРТИФИКАЦИЯ КАЧЕСТВА

- CE TUV Европейский Стандарт
- ISO9001 Система Менеджмента Качества
- TSE Турецкий институт стандартная сертификация в соответствии
- TSEK Турецкий институт стандартная сертификация в соответствии.
- После продажи,
- Свидетельство о регистрации товарного знака
- Свидетельство о регистрации товарного знака Европейского Сообщества CTM
- Свидетельство о регистрации товарного знака по Мадридской системе международной регистрации знаков, администрируемой ВОИС
- ISCIR (РОМЕНИЯ)
- GOST (РОССИЯ)

2 Makine ve 2 Operatör yerine 1 Makine ve 1 Operatör sayesinde ceketin ön (Sağ/Sol) ve arka (Sağ/Sol) tüm kısımlarını ütüleme. Bu sayede alan ve enerji tasarrufu.

Space and energy saving by ironing of full jacket front & back (right & left) with one press and one operator instead of two presses and two operators

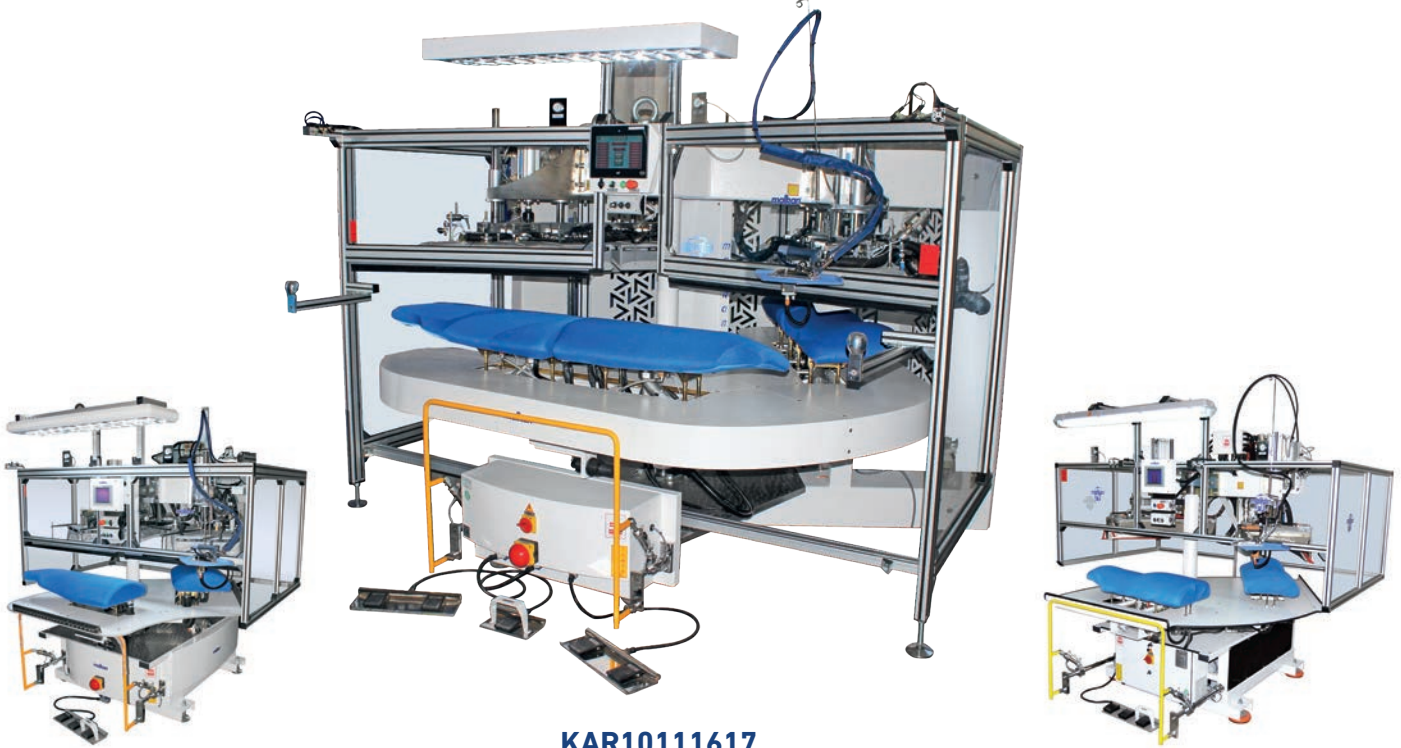

KAR1011S

KAR10111617

KAR1617S



Dokunmatik ekran PLC panel
Touch screen PLC

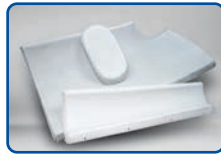

KD Plate kaplama özelliği
KD Plate covering feature



Emniyet bariyeri
Safety barrier



**KAR10111617
KARUSEL SİSTEM, CEKET GÖĞÜS VE SIRT FORM
ÜTÜ PRESİ (SAĞ - SOL BİR ÜNİTE)**

- Bilgisayar (PLC) kontrollü 10,2" renkli dokunmatik panel ile 140 farklı program
- Makine fonksiyonlarını ekrandan manuel kontrol edebilme özelliği
- Program kopyalama özelliği
- Ütülene iş adetini sayma özelliği
- Kaplama zaman uyarısı
- En son trendlere uygun tasarlanmış tam oturan kalıplar
- Alt tablada 4 kalıp ile 120° dönme
- Üst kalıpta kademeli programlanabilir vakum ve çevre vakum sistemi
- Üst kalıpta kademeli programlanabilir buhar verme
- Buhar ve hava için orantılama tekniği
- Üst kalıpta bölme sistemi
- Alt kalıpta sabit vakum ayrıca kademeli programlanabilir vakum
- Dönme vakumu ile ürünü sabitleme
- Serpantinli alüminyum kalıplar ile enerji tasarrufu
- Her cins kumaşa göre kademeli basınç kontrolü (dijital) ve me- safe kontrolü
- Pat-patlama fonksiyonu
- Lazer işaretleme ışını ile standart yerleştirme ve yüksek ütüleme kalitesi
- Emniyet donanımlı ütü koyma yeri ve el ütüsü

**KAR10111617
CAROUSEL SYSTEM JACKET FRONT AND BACK
FORM IRONINGPRESS (RIGHT-LEFT ONE UNIT)**

- 140 different programs 10,2" with touch screen computer (PLC) control
- Manual control for working functions on the screen
- Copy-Paste for ready programme
- Counter for out-put
- Covering time alert on the screen
- Best buck forms according to new fashion trends
- On the lower plate turning 120° with 4 lower bucks
- Programmable upper mold-stage vacuum
- Programmable step steaming on upper buck with edge vacuum system
- Proportioning technique for steam and air
- Upper mold partition system
- Fix vacuum and programmable step vacuuming on lower buck
- Jacket Fixing with turning vacuum
- Energy saving with serpentine is aluminium bucks
- Digital pressure control and distance control for every type of fabric
- Pat-pat ironing function
- Standart placing of jacket by laser pointers on bucks and high ironing quality
- Hand iron and hand iron base with security equipment

KAR1011

KARUSEL SİSTEM, CEKET GÖĞÜS FORM ÜTÜ PRESİ (SAĞ - SOL BİR ÜNİTE 180°)
CAROUSEL SYSTEM, JACKET FRONT FORM IRONING PRESS (RIGHT - LEFT ONE UNIT 180°)
КАРУСЕЛЬНЫЙ ПРЕСС ДЛЯ ПОЛОЧКИ



KAR1011S

KARUSEL SİSTEM, CEKET GÖĞÜS FORM ÜTÜ PRESİ (SAĞ - SOL BİR ÜNİTE 120°)
CAROUSEL SYSTEM, JACKET FRONT FORM IRONING PRESS (RIGHT-LEFT ONE UNIT 120°)
ВРЩАЮЩИЙСЯ СИСТЕМА САКО ГРУДНОЙ ЖЕЛЕЗНЫЙ



DIK1011

PNÖMATİK DİK SİSTEM CEKET GÖĞÜS FORM ÜTÜ PRESİ (SAĞ - SOL İKİ ÜNİTE)
PNEUMATIC VERTICAL SYSTEM JACKET FRONT FORM IRONING PRESS (RIGHT - LEFT TWO UNITS)
ВЕРТИКАЛЬНЫЙ ПРЕСС ДЛЯ ПОЛОЧКИ ПИДЖАКА



UPP10LUPP11L

PNÖMATİK LİNEAR SİSTEM DİK BASKILI CEKET GÖĞÜS FORM ÜTÜ PRESİ (SAĞ-SOL İKİ ÜNİTE)
PNEUMATIC LINEAR SYSTEM VERTICAL FRONT FORM IRONING PRES (RIGHT-LEFT TWO UNIT)
Пневматический линейный вертикальный пресс для формовки передней части пиджака (правая-левая стороны двух изделий)



UPP1011L

PNÖMATİK LİNEAR SİSTEM DİK BASKILI CEKET GÖĞÜS FORM ÜTÜ PRESİ(SAĞ-SOL BİR ÜNİTE)
PNEUMATIC LINEAR SYSTEM VERTICAL FRONT FORM IRONING PRES (RIGHT-LEFT ONE UNIT)
Пневматический линейный вертикальный пресс для формовки передней части пиджака (правая-левая стороны одного изделия) двух изделий)



UPP1011KI

PNÖMATİK, KIZAKLI SİSTEM CEKET GÖĞÜS FORM ÜTÜ PRESİ (SAĞ - SOL BİR ÜNİTE)
PNEUMATIC, LINEAR SYSTEM JACKET FRONT FORM IRONING PRESS (RIGHT-LEFT ONE UNIT)
ПНЕВМАТИЧЕСКИЙ ЛИНЕЙНОЙ ГЛАДИЛЬНЫЙ ПРЕСС ДЛЯ ПОЛОЧКИ



UPP10DIUPP11DI

PNÖMATİK, MAKASLI DİK BASKILI CEKET GÖĞÜS FORM ÜTÜ PRESİ (SAĞ - SOL İKİ ÜNİTE)
PNEUMATIC SCISSORS-VERTICAL SYSTEM JACKET FRONT FORM IRONING PRESS (RIGHT-LEFT TWO UNITS)
ПНЕВМАТИЧЕСКИЙ НОЖНИЦЫЙ-ВЕРТИКАЛЬНЫЙ ПРЕСС ДЛЯ ПОЛОЧКИ



UP10UP11

MANUEL SİSTEM, CEKET GÖĞÜS FORM ÜTÜ PRESİ (SAĞ - SOL İKİ ÜNİTE)
MANUAL SYSTEM JACKET FRONT FORM IRONING PRESS (RIGHT-LEFT TWO UNITS)
МЕХАНИЧЕСКИЙ ПРЕСС ДЛЯ ПОЛОЧКИ



KAR1617

KARUSEL SİSTEM, CEKET SIRT FORM ÜTÜ PRESİ (SAĞ - SOL BİR ÜNİTE 180°)
CAROUSEL SYSTEM, JACKET BACK FORM IRONING PRESS (RIGHT - LEFT ONE UNIT 180°)
КАРУСЕЛЬНЫЙ ПРЕСС ДЛЯ СПИНКА-ОКОНЧАТЕЛЬНАЯ



KAR1617S

KARUSEL SİSTEM, CEKET SIRT FORM ÜTÜ PRESİ (SAĞ - SOL BİR ÜNİTE 120°)
CAROUSEL SYSTEM JACKET BACK FORM IRONING PRESS (RIGHT - LEFT ONE UNIT 120°)
ВРАЩАЮЩИЙСЯ СИСТЕМА САКО СПИННОЙ ЖЕЛЕЗНЫЙ

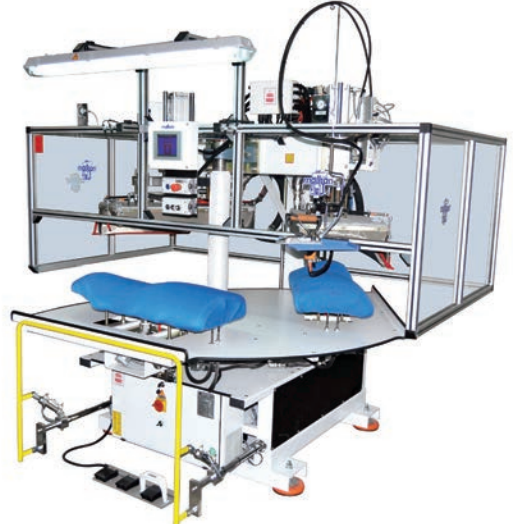

DIK1617

PNÖMATİK DİK SİSTEM CEKET SIRT FORM ÜTÜ PRESİ (SAĞ - SOL İKİ ÜNİTE)
PNEUMATIC VERTICAL SYSTEM JACKET BACK FORM IRONING PRESS (RIGHT - LEFT TWO UNITS)
ВЕРТИКАЛЬНЫЙ ПРЕСС ДЛЯ СПИНКА-ОКОНЧАТЕЛЬНАЯ

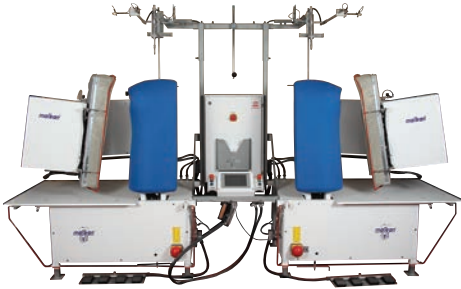

UPP16LUPP17L

PNÖMATİK LINEAR SİSTEM DİK BASKILI SIRT FORM ÜTÜ PRESİ (SAĞ-SOL İKİ ÜNİTE)
PNEUMATIC LINEAR-VERTICAL SYSTEM BACK FORM IRONING PRESS (RIGHT-LEFT TWO UNITS)
Пневматический линейно-вертикальный пресс для формовки задней части пиджака (правая -левая стороны одного изделия)



UPP1617L

PNÖMATİK LINEAR DİK BASKILI SİSTEM SIRT FORM ÜTÜ PRESİ (SAĞ-SOL BİR ÜNİTE)
PNEUMATIC LINEAR-VERTICAL SYSTEM BACK FORM IRONING PRESS (RIGHT-LEFT ONE UNIT)
Пневматический линейно-вертикальный пресс для формовки задней части пиджака (правая -левая стороны одного изделия)



UPP1617KI

PNÖMATİK, KIZAKLI SİSTEM CEKET SIRT FORM ÜTÜ PRESİ (SAĞ - SOL BİR ÜNİTE)
PNEUMATIC LINEAR SYSTEM JACKET BACK FORM IRONING PRESS (RIGHT-LEFT ONE UNIT)
ПНЕВМАТИЧЕСКИЙ ЛИНЕЙНОЙ ПРЕСС ДЛЯ СПИНКА-ОКОНЧАТЕЛЬНАЯ



UPP16DIUPP17DI

PNÖMATİK, MAKASLI DİK BASKILI CEKET SIRT FORM ÜTÜ PRESİ (SAĞ - SOL İKİ ÜNİTE)
PNEUMATIC SCISSORS-VERTICAL SYSTEM JACKET BACK FORM IRONING PRESS (RIGHT-LEFT TWO UNITS)
ПНЕВМАТИЧЕСКИЙ НОЖНИЦЫЙ-ВЕРТИКАЛЬНЫЙ ПРЕСС ДЛЯ СПИНКА-ОКОНЧАТЕЛЬНАЯ



UPP1617

MANUEL SİSTEM, CEKET SIRT FORM ÜTÜ PRESİ (SAĞ - SOL İKİ ÜNİTE)
MANUAL SYSTEM JACKET BACK FORM IRONING PRESS (RIGHT-LEFT TWO UNITS)
МЕХАНИЧЕСКИЙ ПРЕСС ДЛЯ СПИНКА-ОКОНЧАТЕЛЬНАЯ



**UPP8D**
**PNÖMATİK, DİK SİSTEM CEKET
OMUZ ÜTÜ PRESİ
(SAĞ - SOL BİR ÜNİTE)**

PNEUMATIC, VERTICAL SYSTEM
JACKET SHOULDER IRONING
PRESS (RIGHT-LEFT ONE UNIT)

ПНЕВМАТИЧЕСКИЙ
ВЕРТИКАЛЬНЫЙ ГЛАДИЛЬНЫЙ
ПРЕСС ДЛЯ ПЛЕЧА

**UPP8**
**PNÖMATİK, MAKASLI SİSTEM CEKET
OMUZ ÜTÜ PRESİ (SAĞ-SOL BİR
ÜNİTE)**

PNEUMATIC SCISSORS SYSTEM
JACKET SHOULDER IRONING PRESS
(RIGHT-LEFT ONE UNIT)

ПНЕВМАТИЧЕСКИЙ ГЛАДИЛЬНЫЙ
ПРЕСС ДЛЯ ПЛЕЧА

**UPP9D3**
**PNÖMATİK, DİK SİSTEM CEKET
ÜÇLÜ YAKA KIRMA ÜTÜ PRESİ**

PNEUMATIC, VERTICAL SYSTEM
TRIPLE JACKET COLLAR IRONING
AND FOLDING PRESS

ПНЕВМАТИЧЕСКИЙ,
ВЕРТИКАЛЬНЫЙ
ТРЕХГОЛОВОЧНЫЙ ПРЕСС ДЛЯ
ВОРОТНИКА

**UPP9D**
**PNÖMATİK, DİK SİSTEM CEKET YAKA
KIRMA ÜTÜ PRESİ (KISA MANKEN)**

PNEUMATIC VERTICAL SYSTEM
JACKET COLLAR IRONING AND
FOLDING PRESS (SHORT MANNEQUIN)

ПНЕВМАТИЧЕСКИЙ ВЕРТИКАЛЬНЫЙ
ОДНОГОЛОВОЧНЫЙ ПРЕСС ДЛЯ
ВОРОТНИКА

**UPP9EDI**
**PNÖMATİK, MAKASLI DİK BASKILI
YAKA ENSE ÜTÜ PRESİ**

PNEUMATIC, SCISSORS SYSTEM
VERTICAL COLLAR NAPE IRON
PRESS

ПНОМАТИК НОЖНИЧА
ВЕРТИКАЛЬНАЯ ПЕЧАТНЫХ
ВОРОТНИК ЗАТЫЛОК ЖЕЛЕЗНЫЙ

**UP9B**
**MANUEL SİSTEM CEKET YAKA KIRMA
ÜTÜ PRESİ (UZUN MANKEN)**

MANUAL SYSTEM JACKET COLLAR
IRONING AND FOLDING PRESS (LONG
MANNEQUIN)

МЕХАНИЧЕСКИЙ, ОДНОГОЛОВОЧНЫЙ
ПРЕСС ДЛЯ ВОРОТНИКА

KAR28S1

KARUSEL SİSTEM CEKET KOL DİRSEK SON ÜTÜ PRESİ
CAROUSEL SYSTEM JACKET ARMHOLE ELBOW FINAL IRONING PRESS
КАРУСЕЛЬ СИСТЕМА КУРТКА РУКА КОЛЕНА ФИНАЛ ГЛАЖЕНЫЙ ПРЕСС



KAR28S2

KARUSEL SİSTEM CEKET KOL İÇ SON ÜTÜ PRESİ
CAROUSEL SYSTEM JACKET ARMHOLE INTERNAL FINAL IRONING PRESS
КАРУСЕЛЬ СИСТЕМА КУРТКА РУКА ВНУТРЕННОСТЬ ФИНАЛ ГЛАЖЕНЫЙ ПРЕСС



UPP28LS1

LİNEAR SİSTEM PNÖMATİK DİK BASKILI CEKET KOL DİŞ SON ÜTÜ PRESİ
LINEAR-VERTICAL SYSTEM PNEUMATIC JACKET ARM INNER FINISHING PRESS

Пневматический линейно-вертикальный пресс для финальной обработки внешней и внутренней сторон рукава пиджака



UPP28KIS1

PNÖMATİK KIZAKLI SİSTEM CEKET KOL DİŞ SON ÜTÜ PRESİ
PNEUMATIC LINEAR SYSTEM JACKET ARM INNER FINISHING PRESS

Пневматический линейный пресс для финальной обработки внутренней части рукава пиджака



UPP28DIS1

PNÖMATİK, MAKASLI DİK BASKILI, CEKET KOL DİRSEK SON ÜTÜ PRESİ
PNEUMATIC SCISSORS-VERTICAL SYSTEM, JACKET SELEEVE OUTER FINAL IRONING PRESS

ПНЕВМАТИЧЕСКИЙ,НОЖНИЦЫЙ- ВЕРТИКАЛЬНЫЙ ПРЕСС ДЛЯ РАСКАЛЫВАНИЯ ЛОКТЕВОГО И ВНУТРЕННЕГО ШВОВ РУКАВА



UPP28LS2

LİNEAR SİSTEM PNÖMATİK DİK BASKILI CEKET KOL İÇ SON ÜTÜ PRESİ
LINEAR -VERTICAL SYSTEM PNEUMATIC JACKET OUTER ARM FINISHING PRESS

Пневматический линейно-вертикальный пресс для финальной обработки внешней части рукава пиджака



UPP28KIS2

PNÖMATİK, KIZAKLI SİSTEM CEKET KOL İÇ SON ÜTÜ PRESİ
PNEUMATIC, LINEAR SYSTEM JACKET SELEEVE INNER FINAL PRESS

ПНЕВМАТИЧЕСКИЙ,ЛИНЕИНОЙ ПРЕСС ДЛЯРАСКАЛЫВАНИЯ ЛОКТЕВОГО И ВНУТРЕННЕГО ШВОВ РУКАВА



UPP28DIS2

PNÖMATİK MAKASLI DİK BASKILI CEKET KOL İÇ SON ÜTÜ PRESİİ
PNEUMATIC SCISSOR VERTICAL SYSTEM JACKET ARM OUTER FINISHING PRESS

Пневматический вертикальный пресс с системой "ножницы" для финальной обработки внешней части рукава пиджака



KK002

PNÖMATİK CEKET OMUZ OQŞAMALI, KOL KAVADORA ÜTÜ PRESİ (SAĞ - SOL BİR ÜNİTE)
PNEUMATIC JACKET ARMHOLE AND SLEEVE IRONING PRESS WITH ARMHEAD ROBOT
(RIGHT-LEFT ONE UNIT)
ГЛАДИЛЬНЫЙ ПРЕСС ДЛЯ ПЛЕЧО,ПРОЙМА И РУКАВА ПИДЖАКИ

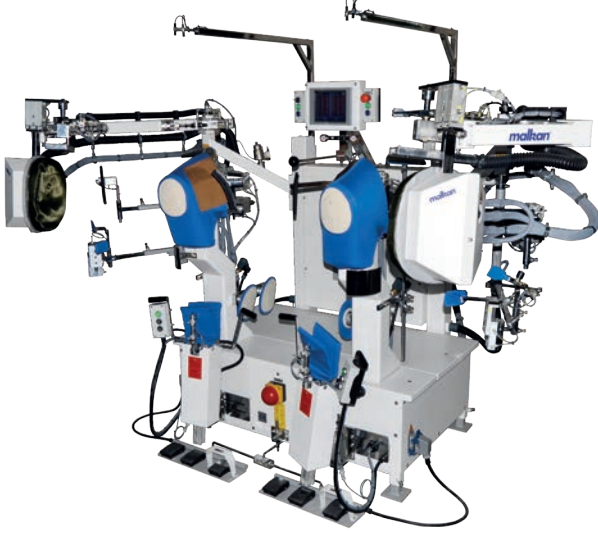

KK001

PNÖMATİK CEKET KOL, KAVADORA, OMUZ ÜTÜ PRESİ (SAĞ - SOL BİR ÜNİTE)
PNEUMATIC JACKET ARMHOLE IRONING PRESS WITH SHOULDER PRESSING UNIT (RIGHT-LEFT ONE UNIT)
ГЛАДИЛЬНЫЙ ПРЕСС ДЛЯ ПЛЕЧО, ПРОЙМА И РУКАВА ПИДЖАКИ

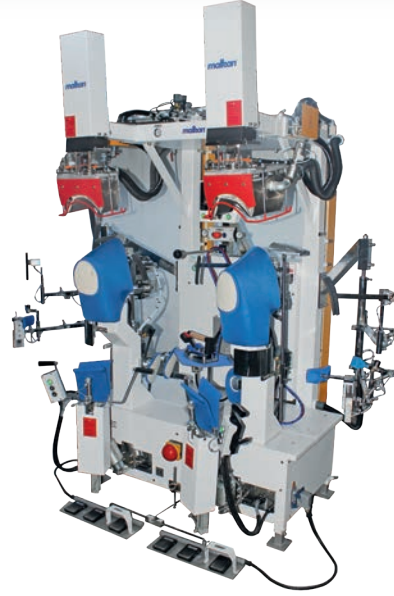

KK003

PNÖMATİK CEKET OMUZ OQŞAMALI, KOL, KAVADORA, OMUZ ÜTÜ PRESİ (SAĞ - SOL BİR ÜNİTE) PNEUMATIC JACKET ARMHOLE AND SLEEVE IRONING PRESS WITH ARMHEAD ROBOT AND SHOULDER PRESSING UNIT (RIGHT-LEFT ONE UNIT)
ГЛАДИЛЬНЫЙ ПРЕСС ДЛЯ ПРОЙМА РУКАВА И ПЛЕЧО ПИДЖАКИ



KARMIYP

KARUSEL SİSTEM, CEKET YAKA YUVARLAMA ÜTÜ PRESİ (SAĞ - SOL BİR ÜNİTE 180°)
CAROUSEL SYSTEM JACKET LAPEL ROUNDING PRESS (RIGHT - LEFT ONE UNIT 180°)



MYYP

LINEAR SİSTEM PNÖMATİK DİK BASKILI YAKA YUVARLAMA PRESİ (SAĞ-SOL BİR ÜNİTE)
LINEAR VERTICAL SYSTEM PNEUMATIC LAPEL ROUNDING PRESS (RIGHT - LEFT ONE UNIT)
Линейно-вертикальный пневматический пресс для обработки лацканов пиджака (правая-левая стороны изделия)



MYYPKI

PNÖMATİK KIZAKLI SİSTEM CEKET YAKA YUVARLAMA ÜTÜ PRESİ (SAĞ - SOL BİR ÜNİTE)
PNEUMATIC LINEAR SYSTEM JACKET LAPEL ROUNDING PRESS (RIGHT-LEFT ONE UNIT)
ЛИНЕЙНЫЙ ГЛАДИЛЬНЫЙ ПРЕСС ДЛЯ КРУГЛОВО ОТВОРОТА



MYYPDI

PNÖMATİK MAKASLI DİK BASKILI CEKET YAKA YUVARLAMA ÜTÜ PRESİ (SAĞ - SOL BİR ÜNİTE)
PNEUMATIC SCISSORS-VERTICAL SYSTEM JACKET LAPEL ROUNDING PRESS (RIGHT-LEFT ONE UNIT)
ПРЕСС НА ПНЕВМАТИЧЕСКОЙ, ВЕРТИКАЛЬНОЙ НОЖНИЦЫЙ СИСТЕМЕ ДЛЯ ШВА РУКАВА ПИДЖАКА (ЛЕВЫЕ И ПРАВЫЕ ДВОЕ ЕДИНИЦЫ)



MY

MANUEL SİSTEM CEKET YAKA YUVARLAMA ÜTÜ PRESİ
MANUAL SYSTEM JACKET LAPEL ROUNDING PRESS
МЕХАНИЧЕСКИЙ ГЛАДИЛЬНЫЙ ПРЕСС ДЛЯ КРУГЛОВО ОТВОРОТА



MCP01

PNÖMATİK CEP KAPAK ÜTÜ PRESİ
PNEUMATIC JACKET POCKET FLAP IRONING PRESS
ПНЕВМАТИЧЕСКИЙ ГЛАДИЛЬНЫЙ ПРЕСС ДЛЯ КЛАПНА КАРМАНА



MCKP

PNÖMATİK CEP KATLAMA PRESİ
PNEUMATIC POCKET FOLDING PRESS
ПНЕВМАТИЧЕСКИЙ ПРЕСС ДЛЯ ФАЛЬЦОВКИ КАРМАНА



KAR10A11A

KARUSEL SİSTEM CEKET SADAFOODRA VE KIL TELA YAPIŞTIRMA ÜTÜ PRESİ
(SAĞ-SOL BİR ÜNİTE 180°)
CAROUSEL SYSTEM JACKET FRONT AND FUSING PRESS (RIGHT- LEFT ONE UNIT 180°)
КАРУСЕЛЬ СИСТЕМА КУРТКА ПЕРЕДНЫЙ И ТЕЛА ПРЕСС (ПРАВЫЙ- ЛЕВЫЙ ОДИН ЧАСТЬ)



KAR10A11AS

KARUSEL SİSTEM CEKET SADAFOODRA VE KIL TELA YAPIŞTIRMA ÜTÜ PRESİ
(SAĞ-SOL BİR ÜNİTE 120°)
CAROUSEL SYSTEM JACKET FRONT AND FUSING PRESS (RIGHT - LEFT ONE UNIT 120°)
КАРУСЕЛЬ СІСТЕМА ГЛАДИЛЬНЫЙ ПРЕСС ДЛЯ ФОРМОВАНИЕ И ДУБЛИРОВАНИЯ РОЛОЧЕК ВНУТРИПРОЦЕССНАЯ



UPP10A11AEL

PNÖMATİK ASANSÖRLÜ SİSTEM CEKET SADAFOODRA VE KIL TELA YAPIŞTIRMA ÜTÜ PRESİ (SAĞ - SOL BİR ÜNİTE)
PNEUMATIC VERTICAL-ROTARY SYSTEM JACKET FRONT AND FUSING PRESS (RIGHT - LEFT ONE UNIT)
РОТОРНЫЙ, ГЛАДИЛЬНЫЙ ПРЕСС ДЛЯ ФОРМОВАНИЕ И ДУБЛИРОВАНИЯ РОЛОЧЕК ВНУТРИПРОЦЕССНАЯ



UPP10ADIUPP11ADI

PNÖMATİK, MAKASLI DİK BASKILI CEKET SADAFOODRA VE KIL TELA YAPIŞTIRMA ÜTÜ PRESİ
(SAĞ - SOL İKİ ÜNİTE)
PNEUMATIC, SCISSORS-VERTICAL SYSTEM JACKET FRONT AND FUSING PRESS (RIGHT-LEFT TWO UNITS)
ПРЕСС НА ПНЕВМАТИЧЕСКОЙ, НОЖНИЦЫЙ СИСТЕМЕ ЧТОБЫ ВЛЕПЛЯТЬ ФРОНТА ПИДЖАКА (ЛЕВЫЕ И ПРАВЫЕ ДВОЕ ЕДИНИЦЫ)



KAR29

KARUSEL SİSTEM CEKET ÜÇLÜ SIRT VE YAN DİKİŞ AÇMA ÜTÜ PRESİ 180°
CAROUSEL SYSTEM JACKET TRIPLE BACK AND SIDE SEAM OPENING PRESS 180°
КАРУСЕЛЬНЫЙ ГЛАДИЛЬНЫЙ ПРЕСС ДЛЯ РАСКАЛЫВАНИЯ БОКОВЫХ И ЗАДЕГО ШВОВ



CCUPD2

**PNÖMATİK, DİK SİSTEM ÇİFTLİ
CEKET CEP ÜTÜ PRESİ**
PNEUMATIC, VERTICAL SYSTEM
DOUBLE JACKET POCKET IRONING
PRESS
ПНОМАТИК ВЕРТИКАЛЬНАЯ
СЕНТЬРНЬ ЧЕТНЫЙ САКО
КАРМАН ЖЕЛЕЗНЫЙ

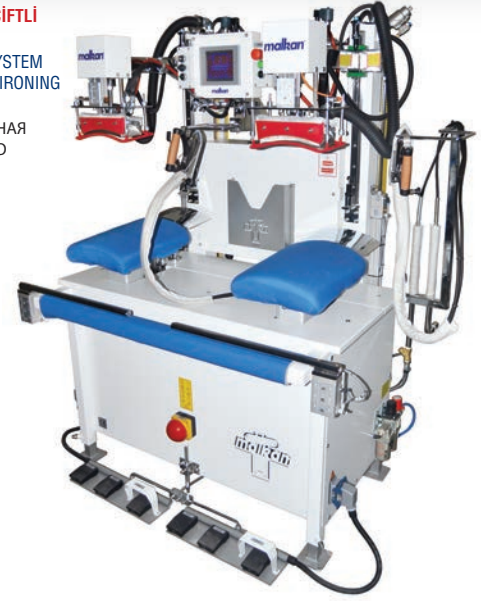

UPP29KI

PNÖMATİK, KIZAKLI SİSTEM CEKET ÜÇLÜ SIRT VE YAN DİKİŞ AÇMA ÜTÜ PRESİ
PNEUMATIC, LINEAR SYSTEM JACKET TRIPLE BACK AND SIDE SEAM OPENING PRESS
ГЛАДИЛЬНЫЙ ПРЕСС НА ПРЕВМА ПНЕВМАТИЧЕСКОЙ СИСТЕМЕ ЧТОБЫ ОТКРЫВАТЬ
ЗАДНОГО БОКОВОГО ШВА ПИДЖАКА



CCUPD

PNÖMATİK DİK SİSTEM CEKET CEP ÜTÜ PRESİ
PNEUMATIC VERTICAL SYSTEM JACKET POCKET
IRONING PRESS
ВЕРТИКАЛЬНЫЙ ГЛАДИЛЬНЫЙ ПРЕСС ДЛЯ
КАРМАНА



UPP29DI

**PNÖMATİK, MAKASLI DİK BASKILI
CEKET ÜÇLÜ SIRT VE YAN DİKİŞ AÇMA
ÜTÜ PRESİ**
PNEUMATIC, SCISSORS-VERTICAL
SYSTEM, TRIPLE BACK AND SIDE SEAM
OPENING PRESS
ГЛАДИЛЬНЫЙ ПРЕСС НА ПРЕВМА
ПНЕВМАТИЧЕСКОЙ ВЕРТИКАЛЬНОЙ
НОЖНИЦЫЙ СИСТЕМЕ ЧТОБЫ
ОТКРЫВАТЬ ЗАДНОГО И БОКОВОГО
ШВА ПИДЖАКА



UPP108

**PNÖMATİK, MAKASLI SİSTEM CEKET
OMUZ SPALA DİKİŞ AÇMA ÜTÜ PRESİ**
PNEUMATIC SCISSORS SYSTEM JACKET
SHOULDER SEAM OPENING PRESS
ПНЕВМАТИЧЕСКИЙ ПРЕСС ДЛЯ
РАСКАЛЫВАНИЯ ПЛЕЧЕВОГО ШВА



KDPKAR

KARUSEL SİSTEM, CEKET KOL DIŞ KAVİS VE DİKİŞ AÇMA ÜTÜ PRESİ (180°)
CAROUSEL SYSTEM JACKET SLEEVE OUTER CURVE AND SEAM OPENING PRESS (180°)
КАРУСЕЛЬНЫЙ ГЛАДИЛЬНЫЙ ПРЕСС ДЛЯ РАСКАЛЫВАНИЯ ШВОВ РУКАВА



KAR28

KARUSEL SİSTEM CEKET KOL İÇ DİKİŞ AÇMA ÜTÜ PRESİ 180°
CAROUSEL SYSTEM JACKET ARMHOLE INTERNAL SEAM OPENING PRESS 180°
КАРУСЕЛЬ СИСТЕМА КУРТКА РУКА ВНУТРЕННОСТЬ ШИТЬЕ ОТКРИВАНИЕ ПРЕСС 180°



KDPKI

**PNÖMATİK KIZAKLI SİSTEM CEKET KOL DIŞ KAVİS
VE DİKİŞ AÇMA ÜTÜ PRESİ**

PNEUMATIC LINEAR SYSTEM JACKET SLEEVE
OUTER CURVE AND SEAM OPENING

Пневматический линейный пресс для
разутюжки локтевого шва пиджака



UPP28KI

PNÖMATİK KIZAKLI SİSTEM CEKET KOL İÇ DİKİŞ AÇMA ÜTÜ PRESİ

PNEUMATIC LINEAR SYSTEM JACKET SLEEVE INNER SIDE SEAM
OPENING PRESS

Пневматический линейный пресс для
разутюжки внутреннего шва рукава пиджака



KDPPDI

**PNÖMATİK, MAKASLI DİK BASKILI
CEKET KOL DIŞ KAVİS VE DİKİŞ AÇMA
ÜTÜ PRESİ**

PNEUMATIC SCISSORS-VERTICAL SYS-
TEM JACKET ELBOW SEAM OPENING
PRESS

ГЛАДИЛЬНЫЙ ПРЕСС НА
ПНЕВМАТИЧЕСКОЙ ВЕРТИКАЛЬНОЙ
НОЖНИУОЙ СИСТЕМЕ ЧТОБЫ
ОТКРЫВАТЬ ЛОКОТОГО ШВА РУКАВА
ПИДЖАКА



UPP28DI

**PNÖMATİK, MAKASLI DİK
BASKILI CEKET KOL İÇ DİKİŞ
AÇMA ÜTÜ PRESİ**

PNEUMATIC SCISSORS VERTI-
CAL SYSTEM JACKET SELEEVE
INNER SEAM OPENING PRESS

ГЛАДИЛЬНЫЙ ПРЕСС
НА ПНЕВМАТИЧЕСКОЙ
ВЕРТИКАЛЬНОЙ НОЖНИУОЙ
СИСТЕМЕ ДЛЯ ШВА РУКАВА
ПИДЖАКА



CEKP

**PNÖMATİK CEKET ETEK KIRMA
ÜTÜ PRESİ**

PNEUMATIC JACKET BOTTOM
FOLDING IRONING PRESS
ГЛАДИЛЬНЫЙ ПРЕСС ДЛЯ
СКЛАДЫВАНИЯ КАЙМЫ
ПИДЖАКИ



UPP8DV3

**PNÖMATİK, CEKET OMUZ
VATKA YAPIŞTIRMA ÜTÜ PESİ
(SAĞ-SOL BİR ÜNİTE)**

PNEUMATIC, JACKET
SHOULDER PADDING BONDING
IRONING PRESS (RIGHT-LEFT
ONE UNIT)
ПНЕВМАТИК ГЛАЖЕНЫЙ
ПРЕСС ЗА ЖАКЕТОМ ПЛЕЧ
ОМ ВАТОМ СКЛЕИВАНИЕМ
(ПРАВЫЙ- ЛЕВЫЙ ОДИН
ЧАСТЬ)



UPP40DI

PNÖMATİK, MAKASLI DİK BASKILI, CEKET KOL SİĞLOMA ÜTÜ PRESİ

PNEUMATIC, SCISSORS-VERTICAL SYSTEM JACKET SLEEVE SEAM STRECH-
ING PRESS
ПНЕВМАТИЧЕСКИЙ НОЖНИЦЫЙ-ВЕРТИКАЛЬНЫЙ ПРЕСС ДЛЯ РУКАВА



KMKP2B

PNÖMATİK CEKET KAVİSLİ MOSTRA VE KENAR ARA ÜTÜ PRESİ (SAĞ - SOL İKİ ÜNİTE)

PNEUMATIC CONCAVE JACKET LAPEL AND EDGE IRONING PRESS (RIGHT - LEFT TWO UNITS)
ГЛАДИЛЬНЫЙ ПРЕСС ДЛЯ ОБРАБОТКИ ОТВАРТОВ БОКОВЫХ-ВНУТРИПРОЦЕСНАЯ



UPP15K

PNÖMATİK CEKET KAVADORA ÜTÜ PRESİ (KALP)
PNEUMATIC JACKET ARMHOLE AND ARM'S LOWER
PART FORM IRONING PRESS (HEART SHAPED)
ПНЕВМАТИК КУРТКА РУКА И ПОДМЫШКА ФОРМ
ГЛАЖЕНЫЙ ПРЕСС (СЕРДЦЕЙ ФОРМА)



UPP15

**PNÖMATİK, MAKASLI SİSTEM KAVADORA VE APATURA
FORM ÜTÜ PRESİ**
PNEUMATIC SCISSORS SYSTEM ARMHOLE AND
ARM'S LOWER PART FORM IRONING PRESS
ПНЕВМАТИЧЕСКИЙ ПРЕСС ДЛЯПРОЙМА И
ФОРМОВАНИЕ



UP15

**MANUEL SİSTEM, CEKET KAVADORA VE
APATURA ÜTÜ PRESİ**
MANUAL SYSTEM JACKET ARMHOLE AND
LOWER PART FORM IRONING PRESS
МЕХАНИЧЕСКИЙ ПРЕСС ДЛЯ ПРОЙМА И
ФОРМОВАНИЕ

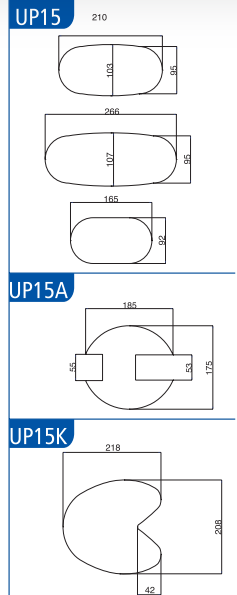

UP106DC

**VAKUMLU, BACALI, ÜFLEMELİ
CEKET RÖTÜŞ TEZGAHI**
JACKET RETOUCHING TABLE WITH
VACUUM, FLUE AND BLOWING
ГЛАДИЛЬНЫЙ СТОЛ С
ВАКУУМОМ, ВЕНТИЛЯТОРОМ
ОТСОСОМ ДЛЯ ФИНИШНАЯ
ОТДЕЛКА



UP21C

**VAKUMLU, BACALI,
ÜFLEMELİ CEKET ASTAR
ÜTÜ TEZGAHI (SU FİSKİYE
SİSTEMLİ)**
JACKET LINING IRONING
TABLE WITH VACUUM, FLUE,
BLOWING AND WATER
EJECTOR SYSTEM
ГЛАДИЛЬНЫЙ
СТОЛ С ВАКУУМОМ,
ВЕНТИЛЯТОРОМ
ОТСОСОМ ДЛЯ
РАЗУТЮЖИВАНИЕ
ПОДКЛАДКИ



MSURC02

CEKET PALTO ÜTÜ ROBOTU
JACKET COAT TOPPER
Пароманекет для
пиджаков и пальто



UP107

VAKUMLU CEKET MOSTRA DİKİŞ AÇMA ÜTÜ TEZGAHI
JACKET LAPEL SEAM OPENING TABLE WITH VACUUM
ВАКУУМНЫМ ПРЕСС ДЛЯ РАЗУТЮЖИВАНИЕ ШВЫ



UP107AY

VAKUMLU, CEKET YAKA DİKİŞ AÇMA ÜTÜ TEZGAHI
JACKET COLLAR SEAM OPENING TABLE WITH VACUUM
ГЛАДИЛЬНЫЙ ПРЕСС ДЛЯ РАСКАЛЫВАНИЯ ШВА
ВАРОТНИКА



UP20MC

**VAKUMLU, BACALI CEKET SASON VE YAN
KUP DİKİŞ AÇMA ÜTÜ TEZGAHI**
JACKET FRONT AND SIDE PART SEAM
OPENING TABLE WITH VACUUM AND
CHIMNEY

Гладильный стол для разутюжки швов на
передней и боковой сторонах пиджака с
вакуумированием и вытяжкой



MKMU01

CEKET KOL MOLA ÜTÜ TEZGAHI (TEKLI)
JACKET SLEEVE HEAD SEAM PUCKER
IRONING TABLE WITH SINGLE BUCK
ГЛАДИЛЬНЫЙ СТОЛ ДЛЯ
ФОРМОВАНИЯ МАНЖЕТЫ



UP28M

VAKUMLU, CEKET KOL (İÇ / DIŞ) DİKİŞ AÇMA ÜTÜ TEZGAHI
JACKET SLEEVE (INNER / OUTER) SEAM OPENING IRONING
TABLE WITH VACUUM
ВАКУУМНЫЙ СТОЛ ДЛЯ РАСКАЛЫВАНИЯ ЛОКТЕВОГО И
ВНУТРЕННЕГО ШВОВ РУКАВА



UP29MC

**VAKUMLU, BACALI, CEKET ÜÇLÜ SIRT, YAN
VE OMUZ DİKİŞ AÇMA ÜTÜ TEZGAHI**
JACKET TRIPLE BACK, SIDE AND SHOULDER
SEAM OPENING IRONING TABLE WITH
VACUUM AND CHIMNEY
ВАКУУМНЫЙ ГЛАДИЛЬНЫЙ СТОЛ ДЛЯ
РАСКАЛЫВАНИЯ БОКОВОГО, ЗАДНЕГО И
ПЛЕЧЕВОГО ШВОВ



UP13

MERKEZİ SİSTEM, ÇİFT KOL APARATLI ÜTÜ MASASI
CENTRAL SYSTEM IRONING TABLE WITH DOUBLE ARMS
ЦЕНТРАЛЬНЫЙ СИСТЕМ ГЛАДИЛЬНЫЙ СТОЛ С ДВУХ РУКАВОМ



UP14

MERKEZİ SİSTEM, KOL APARATLI ÜTÜ MASASI
CENTRAL SYSTEM, IRONING TABLE WITH ARM
ЦЕНТРАЛЬНЫЙ СИСТЕМ ГЛАДИЛЬНЫЙ СТОЛ С РУКАВОМ



UP101AKC

**VAKUMLU, ÜFLEMELİ, KOL APARATLI,
BACALI ÜTÜ PASKALASI**
IRONING BOARD WITH VACUUM, BLOWING,
ARM AND CHIMNEY
ГЛАДИЛЬНЫЙ СТОЛ С ВАКУУМОМ,
ПОДДУВОМ РУКАВОМ



UP10A11AT

**MERKEZİ SİSTEM CEKET SADAFOODRA KIL
TELA YAPIŞTIRMA ÜTÜ TEZGAHI**

CENTRAL SYSTEM JACKET
FRONT HAIR-CLOTH INTERLINING
FUSING TABLE

ГЛАДИЛЬНЫЙ ТАНОК НА
ЦЕНРАЛЬНОЙ СИСТЕМЕ,
ЧТОБЫ ВЛЕПЛЯТЬ ФРОНТА
ПИДЖАКА



UP109Z

**MERKEZİ SİSTEM, CEKET OMUZ
DÜŞÜRME ÜTÜ TEZGAHI**

CENTRAL SYSTEM, JACKET SLEEVE
HEAD SEAM IRONING TABLE

ЦЕНТРАЛЬНЫЙ СИСТЕМ
ГЛАДИЛЬНЫЙ СТОЛ ДЛЯ ПЛЕЧА



UP109ZD

**MERKEZİ SİSTEM, DÖNERLİ
CEKET OMUZ RÖTÜŞ
TEZGAHI**

CAROUSEL CENTER SYS-
TEM, SHOULDER JACKET
RETOUCHING MACHINE

ЦЕНТРАЛЬНЫЙ
ВРАЩАЮЩИЙСЯ СИСТЕМ
ПЛЕЧ КУРТКУ ГЛАДИЛЬНЫЕ
МАШИН



UP107AYZ

**MERKEZİ SİSTEM, VAKUMLU,CEKET YAKA
DİKİŞ AÇMA ÜTÜ TEZGAHI**

CENTER SYSTEM, JACKET COLLAR OPEN
SEWING IRON MACHINE WITH VACUUM

ЦЕНТРАЛЬНЫЙ СИСТЕМ ВАКУУМНЫЙ
СТОЛ КУРТКУА ОШЕЙНИК ШВОВ
ГЛАДИЛЬНАЯ ДОСКА



UP107Z

**MERKEZİ SİSTEM CEKET MOSTRA DİKİŞ
AÇMA ÜTÜ TEZGAHI**

CENTRAL SYSTEM JACKET LAPEL SEAM
OPENING TABLE

ГЛАДИЛЬНЫЙ ТАНОК НА
ЦЕНРАЛЬНОЙ СИСТЕМЕ ЧТОБЫ
ОТКРЫВАТЬ ШВА ЛАЦКАНА ПИДЖАКА



UP102Z

**MERKEZİ SİSTEM BOY AYARLI ÜTÜ
MASASI**

CENTRAL SYSTEM HEIGHT ADJUSTED
IRONING TABLE

ЦЕНТРАЛЬНЫЙ СИСТЕМ ГЛАДИЛЬНЫЙ
СТОЛ, РЕГУЛИРОВКУ ПО ВЫСОТЕ



UP28MZ

**MERKEZİ SİSTEM, CEKET KOL (İÇ / DIŞ) DİKİŞ
AÇMA TEZGAHI**

CENTRAL SYSTEM JACKET TRIPLE BACK, SIDE
AND SHOULDER SEAM OPENING IRONING TABLE

ФИНАЛЬНЫЙ, ГЛАДИЛЬНЫЙ ТАНОК НА
ЦЕНТРАЛЬНОЙ СИСТЕМЕ ЧТОБЫ ОТКРЫВАТЬ
ВНУТРЕННЕГО И ВНЕШНЕГО ШВА РУКАВА
ПИДЖАКА



KDPMZ

**MERKEZİ SİSTEM, CEKET KOL DIŞ DİKİŞ
AÇMA ÜTÜ TEZGAHI**

CENTRAL SYSTEM JACKET SLEEVE OUTER
SEAM OPENING PRESS

ЦЕНТРАЛЬНЫЙ СИСТЕМ ГЛАДИЛЬНЫЙ СТОЛ
ДЛЯ ЛОКТЕВОГО ШВОВ РУКАВА



CCUMZ

MERKEZİ SİSTEM, CEKET CEP ÜTÜ TEZGAHI

CENTRAL SYSTEM, JACKET POCKET IRONING
TABLE

ЦЕНТРАЛЬНЫЙ СИСТЕМ ГЛАДИЛЬНЫЙ СТОЛ
ДЛЯ ОБРАБОТКИ КАРМАНА ПИДЖАКИ



UP101Z

**MERKEZİ SİSTEM, BOY AYARLI ÜTÜ
PASKALASI**

CENTRAL SYSTEM, HEIGHT ADJUSTED
IRONING BOARD

ГЛАДИЛЬНЫЙ ТАНОК НА
ЦЕНРАЛЬНОЙ СИСТЕМЕ, ЕГО
ВЫСОТА МОЖНО УЛАДИТЬ



UP29MZ

**MERKEZİ SİSTEM, CEKET ÜÇLÜ SIRT VE YAN
DİKİŞ AÇMA ÜTÜ TEZGAHI**

CENTRAL SYSTEM JACKET TRIPLE BACK, SIDE
AND SHOULDER SEAM OPENING IRONING
TABLE

ГЛАДИЛЬНЫЙ ТАНОК С ВАКУУМОМ ЧТОБЫ
ОТКРЫВАТЬ СПИННОГО,ПЛЕЧЕВОГО И
БОКОВОГО ШВА ПИДЖАКА



UP108MZ

**MERKEZİ SİSTEM CEKET OMUZ SPALA DİKİŞ
AÇMA ÜTÜ TEZGAHI**

CENTRAL SYSTEM JACKET SHOULDER SEAM
OPENING IRONING BOARD.

ЦЕНТРАЛЬНЫЙ СИСТЕМ ПЛЕЧ КУРТКУ
ГЛАДИЛЬНЫЕ МАШИН



KAR19

KARUSEL SİSTEM, ÇİFT PAÇA PANTOLON ÇİZGİ ÜTÜ PRESİ
CAROUSEL SYSTEM DOUBLE LEGS TROUSERS LINE IRONING PRESS
КАРУСЕЛЬНЫЙ ПРЕСС ДЛЯ ОБРАБОТКИ НОГ ДВУХ ПАР БРЮК



UPP19KI

PNÖMATİK, KIZAKLI SİSTEM ÇİFT PAÇA PANTOLON ÇİZGİ ÜTÜ PRESİ
PNEUMATIC LINEAR SYSTEM DOUBLE LEGS TROUSERS LINE IRONING PRESS
ПНЕВМАТИЧЕСКИЙ ЛИНЕЙНЫЙ ПРЕСС ДЛЯ ОБРАБОТКИ НОГ ОДНОЙ ПАРЫ БПЮК



UPP19L

PNÖMATİK, LINEAR DİK BASKILI SİSTEM ÇİFT PAÇA PANTOLON ÇİZGİ ÜTÜ PRESİ
PNEUMATIC LINEAR-VERTICAL SYSTEM DOUBLE LEGS TROUSERS LINE IRONING PRESS
Пневматический линейный пресс для заутюживания стрелок брюк



UPP19DI

PNÖMATİK, MAKASLI DİK BASKILI ÇİFT PAÇA PANTOLON ÇİZGİ ÜTÜ PRESİ
PNEUMATIC SCISSORS SYSTEM DOUBLE LEGS TROUSERS LINE IRONING PRESS
ПНЕВМАТИЧЕСКИЙ ПРЕСС ДЛЯ ОБРАБОТКИ НОГ БПЮК



UPP18KI

PNÖMATİK, KIZAKLI SİSTEM TEK PAÇA PANTOLON ÇİZGİ ÜTÜ PRESİ
PNEUMATIC, LINEAR SYSTEM SINGLE LEG TROUSERS LINE IRONING PRESS
ПНЕВМАТИЧЕСКИЙ ЛИНЕЙНЫЙ ПРЕСС ДЛЯ ОБРАБОТКИ СТРЕЛОК ОДНОЙ НОГ



UPP18DI

PNÖMATİK MAKASLI DİK BASKILI TEK PAÇA PANTOLON ÇİZGİ ÜTÜ PRESİ
PNEUMATIC SCISSORS-VERTICAL SYSTEM SINGLE LEG TROUSERS LINE IRONING PRESS
ПНЕВМАТИК С НОЖНИЦОМ- ВЕРТИКАЛЬ ПЕЧАТНОМ СИСТЕМОМ ОДНА ШТАНИНА ПАНТОЛОНЫ ЛИНИЯ ГЛАЖЕНЫЙ ПРЕСС



UPP18

PNÖMATİK, MAKASLI SİSTEM TEK PAÇA PANTOLON ÇİZGİ ÜTÜ PRESİ
PNEUMATIC SCISSORS SYSTEM SINGLE LEG TROUSERS LINE IRONING PRESS
ПНЕВМАТИЧЕСКИЕ, ПРЕССОВАНИЕ СТРЕЛОК БРЮЧИН



UPP15PNT

PNÖMATİK MAKASLI SİSTEM PANTOLON ARKA CEP ÜTÜ PRESİ
PNEUMATIC TROUSERS BACK POCKET IRONING PRESS
ГЛАДЛЬНЫЙ ПРЕСС НА ПНЕВМАТИЧЕСКОЙ, НОЖНИЧНОЙ СИСТЕМЕ ДЛЯ ЗАДНОГО КАРМАНА БРЮИ



UPP41KI2

PNÖMATİK, KIZAKLI SİSTEM PANTOLON TELA YAPIŞTIRMA ÜTÜ PRESİ
PNEUMATIC LINEAR SYSTEM TROUSERS FUSING PRESS
ПНЕВМАТИЧЕСКИЙ ЛИНЕЙНЫЙ ДУБЛИРОВОЧНЫЙ ПРЕСС ДЛЯ БРЮКИ



UPP3BRDI

PNÖMATİK, MAKASLI DİK BASKILI FULL SİSTEM PANTOLON KEMER ÜTÜ PRESİ
PNEUMATIC SCISSORS-VERTICAL FULL SYSTEM TROUSERS WAISTBAND IRONING PRESS
 ПНЕВМАТИЧЕСКИЙ, ФУЛЛ СІСТЕМ ВЕРТИКАЛЬНЫЙ ПРЕСС ДЛҀА ОБРАБОТКА ПОЈОСА БРЈОК



UPP3ADI

PNÖMATİK MAKASLI DİK BASKILI PANTOLON KEMER ÜTÜ PRESİ
PNEUMATIC SCISSORS-VERTICAL SYSTEM, TROUSERS WAISTBAND IRONING PRESS
 ПНЕВМАТИК С НОЖНИЦОМ- ВЕРТИКАЛЬ ПЕЧАТНОМ СІСТЕМОМ , ПАНТОЛОНЫ РЕМЕН ГЛАЖЕНЬ ПРЕСС



UPP3L

PNÖMATİK, LINEAR SİSTEM KEMER ÜTÜ PRESİ
PNEUMATIC, LINEAR SYSTEM TROUSERS BELT IRONING PRESS
 ПНЕВМАТИЧЕСКАЯ, ЛІНЕЙНАЯ СІСТЕМА БРЈОКИ ГЛАДИЛЬНЫЙ ПРЕСС



UPP3A

PNÖMATİK, MAKASLI SİSTEM PANTOLON KEMER ÜTÜ PRESİ
PNEUMATIC SCISSORS SYSTEM TROUSERS WAISTBAND IRONING PRESS
 ПНЕВМАТИЧЕСКИЙ ПРЕСС ДЛҀА ОБРАБОТКА ПОЈОСА БРЈОК



UP3A

MANUEL SİSTEM PANTOLON KEMER ÜTÜ PRESİ
MANUAL SYSTEM TROUSERS WAISTBAND IRONING PRESS
 РУЧНОЙ ПРЕСС ДЛҀА ОБРАБОТКА ПОЈОСА БРЈОК



UPP3EDI

PNÖMATİK MAKASLI DİK BASKILI PANTOLON PİLE BİRLEŞTİRME ÜTÜ PRESİ
PNEUMATIC SCISSORS-VERTICAL TROUSERS WAISTBAND IRONING PRESS
 ГЛАДИЛЬНЫЙ ПРЕСС НА ПНЕВМАТИЧЕСКОЙ, ВЕРТИКАЛЬНОЙ НОЖНИЧНОЙ СІСТЕМЕ УТОБИ ОБЈЕДИНЯТЬ ПОЈАСА БРЈОИК



DUP01

PNÖMATİK PANTOLON DUBLE PAÇA ÜTÜ PRESİ
PNEUMATIC TROUSERS DOUBLE CUFFS (HEM) IRONING PRESS
 ПНЕВМАТИЧЕСКИЙ ПРЕСС ДЛҀА ПРЕССОВАНИЕ БРЈОЧИН



UPP3PT

PANTOLON PATLET PRESİ
TROUSER PLACKET PRESS
 ПАНТОЛОН ПЛАКЕТ ПРЕСС



Formlu Kalıp Çeşitleri
Mould Types in Forms

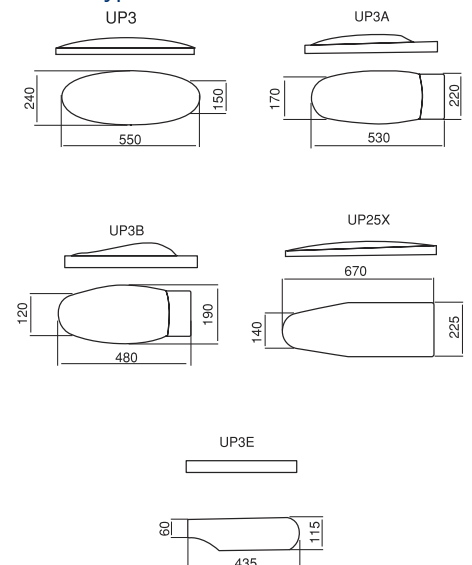

UPP22DI

PNÖMATİK, MAKASLI DİK BASKILIKI PANTOLON YAN DİKİŞ AÇMA ÜTÜ PRESİ (ÇİFTLİ)

PNEUMATIC, SCISSORS-VERTICAL SYSTEM, TROUSERS SIDE SEAM OPENING PRESS (DOUBLE)
ПНЕВМАТИЧЕСКИЙ ПРЕСС ДЛЯ РАСКАЛЫВАНИЯ БОКОВЫХ ШВОВ БРЮКИ



UP22XPVG

VAKUMLU, PNÖMATİK ZİNCİR GERDİRMELİ PANTOLON YAN DİKİŞ AÇMA ÜTÜ TEZGAHI

TROUSERS SIDE SEAM OPENING TABLE WITH VACUUM AND PNEUMATIC CHAIN STRETCHING



UP22XPV

VAKUMLU, MANUEL PANTOLON YAN DİKİŞ AÇMA ÜTÜ TEZGAHI

MANUAL, CHAIN STRETCHING TROUSERS SIDE SEAM OPENING IRONING BOARD WITH VACUUM
РУКОВОДСТВО, НАТЯЖЕНИЕМ ЦЕПИ ШИТЬЕ ОТКРИВАНИЕ ГЛАЖЕНИЯ ТАБЛИЦА С ВАКУУМОМ



UP22XPGZ

MERKEZİ VAKUMLU, PNÖMATİK, ZİNCİR GERDİRMELİ PANTOLON YAN DİKİŞ AÇMA ÜTÜ TEZGAHI

CENTRAL SYSTEM VACUUM, TROUSERS SIDE SEAM OPENING TABLE WITH CHAIN STRETCHING
ЦЕНТР СИСТЕМ ПНЕВМАТИК С НАТЯЖЕНИЕМ ЦЕПОМ ПАНТОЛОНЫ СТОРОНА ШИТЬЕ ОТКРИВАНИЕ ГЛАЖЕННЫЕ СТОЛОВЫЕ

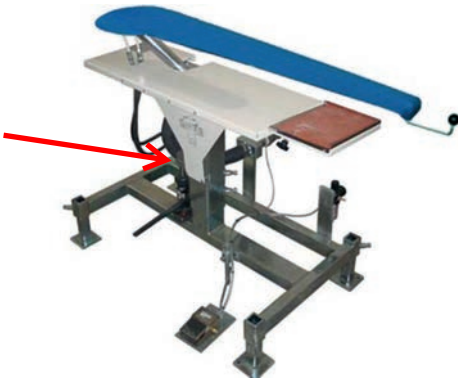

UP22XPGZN

MERKEZİ SİSTEM PNÖMATİK ZİNCİR GERDİRMELİ BORU TİP PANTOLON YAN DİKİŞ AÇMA ÜTÜ TEZGAHI

CENTRAL SYSTEM PNEUMATIC CHAIN STRETCHING PIPE-TYPE TROUSERS SIDE SEAM OPENING TABLE
ЦЕНТР СИСТЕМ ПНЕВМАТИК С НАТЯЖЕНИЕМ ЦЕПОМ ШЛАНГ-ТИП ПАНТОЛОНЫ СТОРОНА ШИТЬЕ ОТКРИВАНИЕ ГЛАЖЕННЫЕ СТОЛОВЫЕ



UP22XPGZN2

MERKEZİ SİSTEM PNÖMATİK ZİNCİR GERDİRMELİ BORU TİPİ ÇİFT APARATLI YAN DİKİŞ AÇMA ÜTÜ TEZGAHI

CENTRAL SYSTEM PNEUMATIC CHAIN STRETCHING PIPE-TYPE WITH DOUBLE APPARATUS SIDE SEAM OPENING TABLE
ЦЕНТР СИСТЕМ ПНЕВМАТИК С НАТЯЖЕНИЕМ ЦЕПОМ ШЛАНГ-ТИП ПАНТОЛОНЫ СТОРОНА ШИТЬЕ ОТКРИВАНИЕ С ПАРНЫМ АППАРАТОМ ГЛАЖЕННЫЕ СТОЛОВЫЕ



UP106KEM

VAKUMLU, ÜFLEMELİ PANTOLON KEMER RÖTUŞ ÜTÜ TEZGAHI

TROUSERS WAISTBAND RETOUCHING TABLE WITH VACUUM AND BLOWING
ГЛАДЛЬНЫЙ СТОЛ С ВАКУУМОМ, ВЕНТИЛЯТОРОМ ОТСОСОМ ДЛЯ ВЕРХНЯЯ ОТДЕЛКА ФИНИШНАЯ



UP23XPV

VAKUMLU, PANTOLON AĞ DİKİŞ AÇMA ÜTÜ TEZGAHI

TROUSERS CROTCH SEAM OPENING TABLE WITH VACUUM
ОТКРЫТИЕ ШВА УЧАСТКА МАЛОЙ СЛОНКИ



UP23XPZ

MERKEZİ SİSTEM PANTOLON AĞ DİKİŞ AÇMA ÜTÜ TEZGAHI

CENTRAL SYSTEM TROUSERS CROTCH SEAM OPENING TABLE
ЦЕНТР СИСТЕМ ПАНТОЛОНЫ СЕТЬ ШИТЬЕ ОТКРИВАНИЕ ГЛАЖЕННЫЕ СТОЛОВЫЕ



*OPSİYONEL KAZANI İÇERİSİNDE ÜRETİLEBİLMEKTEDİR. CAN MANUFACTURE BUILT IN STEAM OPTIONALLY
ЭТО ПРОИЗВОДИТЬСЯ В ДОПОЛНИТЕЛЬНОМ КОТЛЕ

MEK 15/20/30/40/50/60/80/100/120
TAM OTOMATİK, ELEKTRİKLİ MERKEZİ SİSTEM BUHAR JENERATÖRÜ

FULL AUTOMATIC ELECTRICAL CENTRAL SYSTEM STEAM GENERATOR
AVTOMATİЧЕСКИЕ, ЭЛЕКТРИЧЕСКИЕ, ЦЕНТРАЛИЗОВАННОЕ ПАРОГЕНЕРАТОР



BUJ1

MERKEZİ SİSTEM TAM OTOMATİK BUHAR KAZANI
CENTRAL SYSTEM FULL AUTOMATIC STEAM GENERATOR
СЕНТРЬН СИСТЕМА АФТОМАТИЧНЫ ПАР БОЙЛЕР



BUJ2

MERKEZİ SİSTEM TAM OTOMATİK BUHAR JENERATÖRÜ
CENTRAL SYSTEM FULL AUTOMATIC STEAM GENERATOR
АВТОМАТИЧЕСКИЕ, ЦЕНТРАЛИЗОВАННОЕ ПАРОГЕНЕРАТОР



MBUK1/2/4/5/6

TAM OTOMATİK BÜTANGAZLI BUHAR JENERATÖRÜ
FULL AUTOMATIC STEAM GENERATOR WITH LPG
АВТОМАТИЧЕСКИЙ ПАРОГЕНЕРАТОР (ЛПГ)



KOMP

PİSTONLU HAVA KOMPRESÖRÜ
AIR COMPRESSOR WITH PISTON
ПОРШНЕВЫЕ КОМПРЕССОРЫ



TİDİ

VİDALI HAVA KOMPRESÖRÜ
AIR COMPRESSOR WITH SCREW
ВИНТОВЫЕ КОМПРЕССОРЫ



SKK

SESSİZ HAVA KOMPRESÖRÜ (KASALI MODEL)
SILENT AIR COMPRESSOR (CLOSED MODEL)
ВОЗДУШНЫЙ ТИХИЙ КОМПРЕССОРЫ (ОБСАЖЕННЫХ МОДЕЛИ)



KVM

KÖRÜKLÜ VAKUM MOTORU
VACUUM MOTOR WITH BLOWER
ВАКУУМНЫЙ ДВИГАТЕЛЬ С ВЕНТИЛЯТОРОМ



PV1 VAKUM MOTORU (2000 m³)
VACUUM MOTOR / ВАКУУМНЫЙ ДВИГАТЕЛЬ
PV3 VAKUM MOTORU (2500 m³)
VACUUM MOTOR / ВАКУУМНЫЙ ДВИГАТЕЛЬ
PV16 VAKUM MOTORU (5000 m³)
VACUUM MOTOR / ВАКУУМНЫЙ ДВИГАТЕЛЬ



BLOWER

VAKUM MOTORU
VACUUM MOTOR
ВАКУУМНЫЙ ДВИГАТЕЛЬ



SYC20

SU YUMUŞATMA CİHAZI 20 LİTRE
WATER SOFTENER 20 L
ВОДОСМЯГЧИТЕЛЬ



MINI7

YARI OTOMATİK, BİR ÜTÜLÜ BUHAR JENERATÖRÜ (7 LT)

SEMI-AUTOMATIC STEAM JENERATOR WITH ONE HAND IRON (7 L)
ПОЛУАВТОМАТИЧЕСКИЙ ПАРОГЕНЕРАТОР (7Л)



MINI7F

FIRÇA ÜTÜLÜ YARI OTOMATİK BUHAR JENERATÖRÜ (7 LT)

STEAM GENERATOR WITH BRUSH IRON 7LT
Парогенератор со щеткой 7л



UP3011

KATLANABİLİR, KENDİNDEN KAZANLI TEK ÜTÜLÜ ÜTÜ PASKALASI

FOLDABLE IRONING BOARD WITH BUILTIN BOILER
КЛАДНАЯ ГЛАДИЛЬНАЯ ДОСКА СО ВСТРОЕННЫМ ПАРОГЕНЕРАТОРОМ



BF070B

BIEFFE VAKUMLU, KENDİNDEN KAZANLI, KATLANABİLİR ÜTÜ PASKALASI (2 LT)

BIEFFE FOLDABLE, IRONING BOARD WITH VACUM AND BOILER (2 L)
ГЛАДЛЬНЫЙ СТАНОК С СВОЕМ КОТЕЛОМ И С ВАКУУМОМ, МОЖНО ГНУТЬ (2Л)



MINIF

FIRÇA ÜTÜLÜ BUHAR JENERATÖRÜ 1/2/3.5 LT

STEAM GENERATOR WITH BRUSH IRON 1/2/3.5 L
ОТПАРИВАТЕЛЬ С ЭЛЕКТРОПАРОВАМ ЩЕТКАМ



BF084

BIEFFE VAKUMLU, KENDİNDEN KAZANLI KATLANABİLİR ÜTÜ PASKALASI (3,5 LT)

BIEFFE FOLDABLE IRONING BOARD WITH VACUUM AND BOILER (3,5 L)
ГЛАДЛЬНЫЙ СТОЛ (СКЛАДНОЙ) (3,5 л)



MINI2000

BİR ÜTÜLÜ BUHAR JENERATÖRÜ 1 LT

STEAM GENERATOR WITH ONE HAND IRON 1 L
ПАРОГЕНЕРАТОР НАСТОЛНЫЙ С ОДНИМ УТЮГОМ (1Л)



MINI2002

BİR ÜTÜLÜ BUHAR JENERATÖRÜ 2 LT

STEAM GENERATOR WITH ONE HAND IRON 2 L
ПАРОГЕНЕРАТОР НАСТОЛНЫЙ С ОДНИМ УТЮГОМ (2Л)



MINI2035

BİR ÜTÜLÜ BUHAR JENERATÖRÜ 3.5 LT

STEAM GENERATOR WITH ONE HAND IRON 3.5 L
ПАРОГЕНЕРАТОР НАСТОЛНЫЙ С ОДНИМ УТЮГОМ (3,5Л)



MINI2005

BİR ÜTÜLÜ BUHAR JENERATÖRÜ 5 LT

STEAM GENERATOR WITH ONE HAND IRON 5 L
ПАРОГЕНЕРАТОР НАСТОЛНЫЙ С ОДНИМ УТЮГОМ (5Л)



UP100P2

TAM OTOMATİK İKİ ÜTÜLÜ BUHAR JENERATÖRÜ
FULL AUTOMATIC STEAM GENERATOR WITH TWO HAND IRONS
АВТОМАТИЧЕСКИЙ ПАРОГЕНЕРАТОР С ДВУМЯ УТЮГОМИ



UP100P3

TAM OTOMATİK ÜÇ ÜTÜLÜ BUHAR JENERATÖRÜ
FULL AUTOMATIC STEAM GENERATOR WITH THREE HAND IRONS
АВТОМАТИЧЕСКИЙ ПАРОГЕНЕРАТОР С ТРЕМЯ УТЮГОМИ



UP100P4

TAM OTOMATİK DÖRT ÜTÜLÜ BUHAR JENERATÖRÜ
FULL AUTOMATIC STEAM GENERATOR WITH FOUR HAND IRONS
АВТОМАТИЧЕСКИЙ ПАРОГЕНЕРАТОР С ЧЕСЫРЬМЯ УТЮГОМИ



UP1002

YARI OTOMATİK İKİ ÜTÜLÜ BUHAR JENERATÖRÜ
SEMI-AUTOMATIC STEAM GENERATOR WITH TWO HAND IRONS
ПОЛУАВТОМАТИЧЕСКИЙ ПАРОГЕНЕРАТОР С ДВУМЯ УТЮГОМИ



UP100P2K

TAM OTOMATİK İKİ PISTOLELİ BUHAR JENERATÖRÜ
FULL AUTOMATIC STEAM GENERATOR WITH TWO PISTOLS
АВТОМАТИЧЕСКИЙ ПАРОГЕНЕРАТОР С ДВУМЯ ПИСТОЛЕТАМИ



MINIK

YARI OTOMATİK, BİR PISTOLELİ KÜRKÇÜ BUHAR JENERATÖRÜ 7 LT
SEMI-AUTOMATIC STEAM GENERATOR WITH ONE PISTOL FOR FUR
ПОЛУАВТОМАТИЧЕСКИЙ ПАРОГЕНЕРАТОР С ОДНИМ ПИСТОЛЕТАМ ДЛЯ МЕХИ (7L)



MINI2002K

KÜRKÇÜ BİR PISTOLELİ BUHAR JENERATÖRÜ 2 LT
STEAM GENERATOR WITH ONE PISTOL FOR FUR 2 L
ПАРОГЕНЕРАТОР С ОДНИМ ПИСТОЛЕТАМ ДЛЯ МЕХИ (2L)



UP100P2A

TAM OTOMATİK İKİ ÇIKIŞLI KUYUMCU BUHAR JENERATÖRÜ
FULL AUTOMATIC STEAM GENERATOR WITH TWO OUTLETS FOR JEWELLERY
ПАРОГЕНЕРАТОР С ДВУХ ТОЧЕК ДЛЯ УКРАШЕНИЯ



UP100P2AP

TAM OTOMATİK İKİ ÇIKIŞLI KUYUMCU BUHAR JENERATÖRÜ (PASLANMAZ KASA)
FULL AUTOMATIC STEAM GENERATOR WITH TWO OUTLETS FOR JEWELLERY (STAINLESS STEEL)
ПАРОГЕНЕРАТОР С ДВУХ ТОЧЕК ДЛЯ УКРАШЕНИЯ (НЕРЖАВЕЮЩАЯ СТАЛЬ)



MINI7AP

YARI OTOMATİK, BİR ÇIKIŞLI KUYUMCU BUHAR JENERATÖRÜ 7 LT (PASLANMAZ KASA)
SEMI-AUTOMATIC STEAM GENERATOR WITH ONE OUTLET FOR JEWELLERY 7 LT (STAINLESS STEEL)
ПОЛУАВТОМАТИЧЕСКИЙ ПАРОГЕНЕРАТОР С ОДНОЙ ТОЧЕК ДЛЯ УКРАШЕНИЯ (НЕРЖАВЕЮЩАЯ СТАЛЬ)



MINI7A

YARI OTOMATİK, BİR ÇIKIŞLI KUYUMCU BUHAR JENERATÖRÜ 7 LT
SEMI-AUTOMATIC STEAM GENERATOR WITH ONE OUTLET FOR JEWELLERY 7 LT
ПОЛУАВТОМАТИЧЕСКИЙ ПАРОГЕНЕРАТОР С ОДНОЙ ТОЧЕК ДЛЯ УКРАШЕНИЯ



UP101

VAKUMLU ÜTÜ PASKALASI
IRONING BOARD WITH VACUUM
ГЛАДИЛЬНИЙ СТОЛ С ВАКУУМОМ



UP101K

VAKUMLU, KOL APARATLI ÜTÜ PASKALASI
IRONING BOARD WITH VACUUM AND ARM
ГЛАДИЛЬНИЙ СТОЛ С ВАКУУМОМ И РУКАВОМ



UP101C

VAKUMLU, BACALI ÜTÜ PASKALASI
IRONING BOARD WITH VACUUM AND CHIMNEY
ГЛАДИЛЬНИЙ СТОЛ ВАКУУМОМ



UP101B

VAKUMLU, BOY AYARLI, ÜTÜ PASKALASI
IRONING BOARD WITH VACUUM AND ADJUSTABLE HEIGHT
ГЛАДИЛЬНИЙ СТОЛ С ВАКУУМОМ И РЕГУЛИРУЕМОЙ
ВЫСОТАЙ



UP101BK

VAKUMLU, BOY AYARLI, KOL APARATLI, ÜTÜ PASKALASI
IRONING BOARD WITH VACUUM, ADJUSTABLE HEIGHT AND ARM
ГЛАДИЛЬНИЙ СТОЛ С ВАКУУМОМ, РУКАВОМ И С
РЕГУЛИРУЕМОЙ ВЫСОТАЙ



UP101BKÇ

VAKUMLU, BOY AYARLI, KOL APARATLI, BACALI ÜTÜ PASKALASI
IRONING BOARD WITH VACUUM, ADJUSTABLE HEIGHT, ARM
AND CHIMNEY
ГЛАДИЛЬНИЙ СТОЛ С ВАКУУМОМ, РУКАВОМ И С
РЕГУЛИРУЕМОЙ ВЫСОТАЙ



UP101A

VAKUMLU, ÜFLEMELİ, ÜTÜ PASKALASI
IRONING BOARD WITH VACUUM AND BLOWING
ГЛАДИЛЬНИЙ СТОЛ С ВАКУУМОМ, РУКАВОМ И ПОДДУВОМ



UP101AKÇ

VAKUMLU, ÜFLEMELİ, KOL APARATLI, BACALI ÜTÜ PASKALASI
IRONING BOARD WITH VACUUM, BLOWING, ARM AND CHIMNEY
ГЛАДИЛЬНИЙ СТОЛ С ВАКУУМОМ, ПОДДУВОМ РУКАВОМ



UP101AKÇIY

**VAKUMLU, ÜFLEMELİ, KOL APARATLI, BACALI, IŞIKLI, BALAN-
SERLİ ÜTÜ PASKALASI**
IRONING BOARD WITH VACUUM, BLOWING, ARM, CHIMNEY,
LIGHT AND BALANCER
ГЛАДИЛЬНИЙ СТОЛ С РУКАВОМ, ВАКУУМОМ, ПОДДУВОМ,
ОСВЕЩЕНИЕМ И БАЛАНСИРОМ



UP102

VAKUMLU ÜTÜ MASASI

IRONING TABLE WITH VACUUM

ПРЯМОУГОЛЬНЫЙ ГЛАДИЛЬНИЙ СТОЛ С ВАКУУМОМ

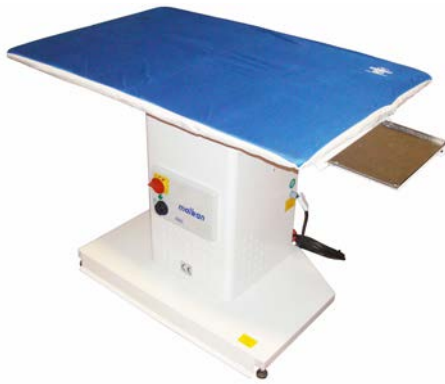

UP102K

VAKUMLU, KOL APARATLI ÜTÜ MASASI

IRONING TABLE WITH VACUUM AND ARM

ПРЯМОУГОЛЬНЫЙ ГЛАДИЛЬНИЙ СТОЛ С ВАКУУМОМ И РУКАВОМ



UP102C

VAKUMLU, BACALI ÜTÜ MASASI

IRONING TABLE WITH VACUUM AND CHIMNEY

ПРЯМОУГОЛЬНЫЙ ГЛАДИЛЬНИЙ СТОЛ С ВАКУУМОМ



UP102B

VAKUMLU, BOY AYARLI ÜTÜ MASASI

IRONING TABLE WITH VACUUM, AND ADJUSTABLE HEIGHT

ПРЯМОУГОЛЬНЫЙ ГЛАДИЛЬНИЙ СТОЛ С ВАКУУМОМ И С РЕГУЛИРУЕМОЙ ВЫСОТОЙ



UP102BK

VAKUMLU, BOY AYARLI, KOL APARATLI ÜTÜ MASASI

IRONING TABLE WITH VACUUM, ADJUSTABLE HEIGHT AND ARM

ПРЯМОУГОЛЬНЫЙ ГЛАДИЛЬНИЙ СТОЛ С ВАКУУМОМ И РУКАВОМ И С РЕГУЛИРУЕМОЙ ВЫСОТОЙ



UP102BKC

VAKUMLU, BOY AYARLI, KOL APARATLI, BACALI ÜTÜ MASASI

IRONING TABLE WITH VACUUM, ADJUSTABLE HEIGHT, ARM AND CHIMNEY

ПРЯМОУГОЛЬНЫЙ ГЛАДИЛЬНИЙ СТОЛ С ВАКУУМОМ И РУКАВОМ И С РЕГУЛИРУЕМОЙ ВЫСОТОЙ



UP102A

VAKUMLU, ÜFLEMELİ, ÜTÜ MASASI

IRONING TABLE WITH VACUUM AND BLOWING

ПРЯМОУГОЛЬНЫЙ ГЛАДИЛЬНИЙ СТОЛ С ВАКУУМОМ И ПОДДУВОМ



UP102AKC

VAKUMLU, ÜFLEMELİ, KOL APARATLI, BACALI ÜTÜ MASASI

IRONING TABLE WITH VACUUM, BLOWING, ARM AND CHIMNEY

ПРЯМОУГОЛЬНЫЙ ГЛАДИЛЬНИЙ СТОЛ С ВАКУУМОМ И ПОДДУВОМ, РУКАВОМ



UP102AKCIY

VAKUMLU, ÜFLEMELİ, KOL APARATLI, BACALI, IŞIKLI, BALANSERLİ ÜTÜ MASASI

IRONING TABLE WITH VACUUM, BLOWING, ARM, CHIMNEY, LIGHT AND BALANCER

ПРЯМОУГОЛЬНЫЙ ГЛАДИЛЬНИЙ СТОЛ С РУКАВОМ, ВАКУУМОМ И ПОДДУВОМ, ОСВЕЩЕНИЕМ И БАЛАНСИРОМ



UP402

ISITMASIZ, YÜKSEK VAKUMLU, ÜTÜ MASASI
IRONING TABLE WITHOUT HEATER WITH STRONG VACUUM
ПРЯМОУГОЛЬНЫЙ ГЛАДИЛЬНИЙ СТОЛ БЕЗ
ПОДЕГРЕВОМ И С ВАКУУМОМ



UP402

UP402C

UP401

ISITMASIZ, YÜKSEK VAKUMLU, ÜTÜ PASKALASI
IRONING BOARD WITHOUT HEATER WITH STRONG VACUUM
ГЛАДИЛЬНИЙ СТОЛ БЕЗ ПОДЕГРЕВОМ И С ВАКУУМОМ



UP401

UP401C

UP301

VAKUMLU SINDİ EV TİPİ ÜTÜ PASKALASI
SINDY HOUSEHOLD TYPE IRONING BOARD WITH VACUUM
ГЛАДИЛЬНАЯ ДОСКА С ВАКУУМОМ



EKO101

EKONOMİK MODEL, VAKUMLU ÜTÜ PASKALASI
ECONOMIC MODEL, IRONING BOARD WITH VACUUM
ЭКОНОМИЧЕКИЙ МОДЕЛ ГЛАДИЛЬНАЯ ДОСКА С ВАКУУМОМ



EKO101K

EKONOMİK MODEL, VAKUMLU, KOL APARATLI ÜTÜ PASKALASI
ECONOMIC MODEL, IRONING BOARD WITH VACUUM AND ARM
ЭКОНОМИЧЕКИЙ МОДЕЛ ГЛАДИЛЬНАЯ ДОСКА С
ВАКУУМОМ



UP302

VAKUMLU SINDİ EV TİPİ ÜTÜ MASASI
SINDY HOUSEHOLD TYPE IRONING TABLE WITH VACUUM
ПРЯМОУГОЛЬНАЯ ГЛАДИЛЬНАЯ ДОСКА С ВАКУУМОМ



EKO102

EKONOMİK MODEL, VAKUMLU ÜTÜ MASASI
ECONOMIC MODEL, IRONING TABLE WITH VACUUM
ЭКОНОМИЧЕКИЙ МОДЕЛ ПРЯМОУГОЛЬНАЯ ГЛАДИЛЬНАЯ
ДОСКА С ВАКУУМОМ



EKO102K

EKONOMİK MODEL, VAKUMLU, KOL APARATLI ÜTÜ MASASI
ECONOMIC MODEL, IRONING TABLE WITH VACUUM AND ARM
ЭКОНОМИЧЕКИЙ МОДЕЛ ПРЯМОУГОЛЬНАЯ ГЛАДИЛЬНАЯ
ДОСКА С ВАКУУМОМ И РУКАВОМ



UP5011

**VAKUMLU, ISITMASIZ KENDINDEN KAZANLI
TEK ÜTÜLÜ ÜTÜ PASKALASI**
IRONING BOARD WITHOUT HEATER, WITH
VACUUM AND BUILT IN BOILER
ГЛАДИЛЬНЫЙ КОНСОЛ БЕЗ НАГРЕВАТЕЛЕМ,
С ВАКУМОМ И БОЙЛЕРОМ



UP2011

**VAKUMLU, KENDİNDEN KAZANLI, TEK ÜTÜLÜ
ÜTÜ PASKALASI**
IRONING BOARD WITH VACUUM, BOILER AND
ONE HAND IRON
ГЛАДИЛЬНЫЙ СТОЛ С ВАКУМОМ И
БОЙЛЕРОМ С ОДНИМ УТЮГОМ



UP2011K

**VAKUMLU, KENDİNDEN KAZANLI, KOL APARATLI,
TEK ÜTÜLÜ ÜTÜ PASKALASI**
IRONING BOARD WITH VACUUM, BOILER, ARM
AND ONE HAND IRON
ГЛАДИЛЬНЫЙ СТОЛ С
ВАКУМОМ, БОЙЛЕРОМ РУКАВОМ И С
ОДНИМ УТЮГОМ



UP2012

**VAKUMLU, KENDİNDEN KAZANLI, İKİ ÜTÜLÜ,
ÜTÜ PASKALASI**
IRONING BOARD WITH VACUUM, BOILER AND
TWO HAND IRONS
ГЛАДИЛЬНЫЙ СТОЛ С
ВАКУМОМ, БОЙЛЕРОМ
И С ДВУМЯ УТЮГАМИ



UP5021

**VAKUMLU, ISITMASIZ KENDİNDEN
KAZANLI TEK ÜTÜLÜ ÜTÜ MASASI**
IRONING TABLE WITHOUT
HEATER, WITH VACUUM AND
BUILT IN BOILER.
ГЛАДИЛЬНЫЙ СТОЛ БЕЗ
НАГРЕВАТЕЛЕМ, С ВАКУМОМ
И БОЙЛЕРОМ



UP2021

**VAKUMLU, KENDİNDEN KAZANLI,
TEK ÜTÜLÜ ÜTÜ MASASI**
IRONING TABLE WITH VACUUM,
BOILER AND ONE HAND IRON
ПРЯМОУГОЛЬНЫЙ
ГЛАДИЛЬНЫЙ СТОЛ С
ВАКУМОМ, И БОЙЛЕРОМ И С
ОДНИМ УТЮГОМ



UP2021K

**VAKUMLU, KENDİNDEN KAZANLI,
KOL APARATLI, TEK ÜTÜLÜ ÜTÜ
MASASI**
IRONING TABLE WITH VACUUM,
BOILER, ARM AND ONE HAND
IRON
ПРЯМОУГОЛЬНЫЙ
ГЛАДИЛЬНЫЙ СТОЛ С
ВАКУМОМ,
БОЙЛЕРОМ, РУКАВОМ И С
ОДНИМ УТЮГОМ



UP2022K

**VAKUMLU, KENDİNDEN
KAZANLI, KOL APARATLI, İKİ
ÜTÜLÜ ÜTÜ MASASI**
IRONING TABLE WITH VACUUM,
BOILER, ARM AND TWO HAND
IRONS
ПРЯМОУГОЛЬНЫЙ
ГЛАДИЛЬНЫЙ СТОЛ С
ВАКУМОМ, БОЙЛЕРОМ,
РУКАВОМ И С ДВУМЯ
УТЮГОМ



UP101FULL

**VAKUMLU, ÜFLEMELİ, KOL VE LEKE APARATLI, BACALI, İŞIKLI, BUHARLI,
DİJİTAL ÜTÜLÜ, BOY AYARLI, KAZANLI, ÜTÜ PASKALASI**
IRONING BOARD WITH BLOWING, ARM, CHIMNEY, LIGHT, SPOT REMOVING,
APPARATUS DIGITAL HAND IRON ADJUSTABLE HEIGHT BOILER
ГЛАДИЛЬНЫЙ СТОЛ С РУКАВОМ, ВАКУМОМ И ПОДДУВОМ,
ОСВЕЩЕНИЕМ, БАЛАНСИРОМ И С ПЯТНОВЫБОДИТЕЛЬ АПАРАТАМ

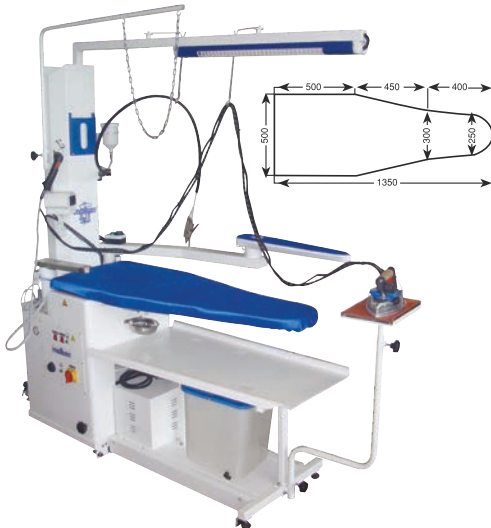

UP112

**VAKUMLU, BUHAR PÜSKÜRTMELİ, KENDİNDEN
KAZANLI, TEK ÜTÜLÜ ÜTÜ PASKALASI**
IRONING BOARD WITH VACUUM, STEAM SPRAYING,
BOILER AND ONE HAND IRON
ГЛАДИЛЬНЫЙ СТОЛ С ВАКУМОМ, БОЙЛЕРОМ И
С ПАРОВОЙ ОДНИМ УТЮГОМ



UP112KIYL

**VAKUMLU, BUHAR PÜSKÜRTMELİ, KENDİNDEN KAZANLI, KOL APARATLI,
İŞIKLI, BALANSERLİ, LEKE APARATLI VE PİSTOLELİ ÜTÜ PASKALASI**
IRONING BOARD WITH VACUUM, STEAM SPRAYING, BOILER, ARM,
LIGHT, BALANCER, SPOT REMOVING APPARATUS AND PISTOL
ГЛАДИЛЬНЫЙ СТОЛ С РУКАВОМ, ВАКУМОМ И ПОДДУВОМ,
ОСВЕЩЕНИЕМ, БАЛАНСИРОМ И С ПЯТНОВЫБОДИТЕЛЬ АПАРАТАМ



UP1/UP2

MANUEL SİSTEM ORTA BOY / BÜYÜK BOY ÜNİVERSAL ÜTÜ PRESİ
MANUAL SYSTEM, MEDIUM SIZE / LARGE SIZE UTILITY IRONING PRESS
НИВЕРСАЛЬНЫЙ ГЛАЖЕНЫЙ ПРЕСС, С РУКОВОДСТВОМ СИСТЕМОМ, БОЛЬШИМ / СРЕДНИМ РАЗМЕРОМ

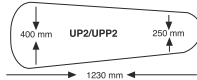
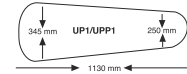

UPP1 / UPP2

PNÖMATİK, MAKASLI SİSTEM ORTA BOY / BÜYÜK BOY ÜNİVERSAL ÜTÜ PRESİ
PNEUMATIC, SCISSORS SYSTEM MEDIUM SIZE / LARGE SIZE UTILITY IRONING PRESS
ПНЕВМАТИЧЕСКИЙ СРЕДНИЙ РАЗМЕР УНИВЕРСАЛЬНЫЙ ПРЕСС

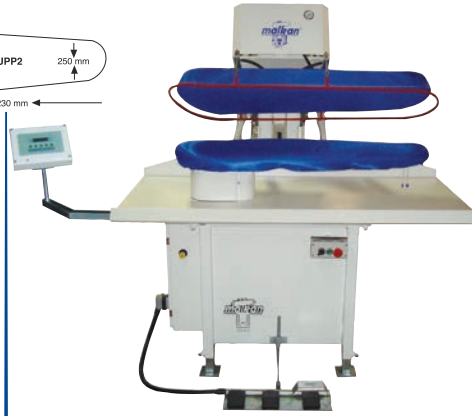

UP43

MANUEL SİSTEM, KÜÇÜK BOY, ÜNİVERSAL ÜTÜ PRESİ
MANUAL SYSTEM, SMALL SIZE, UNIVERSAL IRONING PRESS
РУЧНОЙ УНИВЕРСАЛЬНЫЙ ПРЕСС (Малинкий размер)

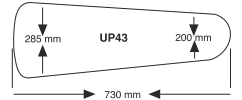
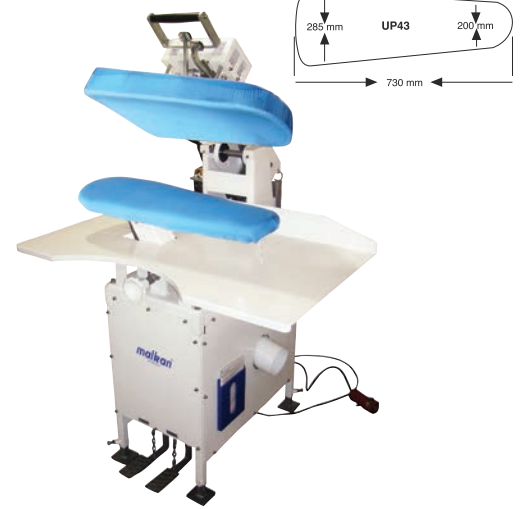

UP1VK / UP2VK

MANUEL SİSTEM, KENDİNDEN KAZANLI, VAKUMLU, ORTA BOY / BÜYÜK BOY ÜNİVERSAL ÜTÜ PRESİ
MANUAL SYSTEM, MEDIUM SIZE / LARGE SIZE UTILITY IRONING PRESS WITH VACUUM AND BOILER
МЕХАНИЧЕСКОГО СРЕДНЕГО РАЗМЕРА УНИВЕРСАЛЬНЫЙ ПРЕСС С ВАКУУМОМ И БОЙЛЕРОМ



UPP1VK / UPP2VK

PNÖMATİK, MAKASLI SİSTEM KENDİNDEN KAZANLI, VAKUMLU, ORTA BOY / BÜYÜK BOY ÜNİVERSAL ÜTÜ PRESİ
PNEUMATIC, SCISSORS SYSTEM MEDIUM SIZE / LARGE SIZE UTILITY IRONING PRESS WITH VACUUM AND BOILER
ПНЕВМАТИЧЕСКИЙ СРЕДНИЙ РАЗМЕР УНИВЕРСАЛЬНЫЙ ПРЕСС С ВАКУУМОМ И БОЙЛЕРОМ



UPP1A / UPP2A

PNÖMATİK, MAKASLI SİSTEM YARI OTOMATİK ORTA BOY / BÜYÜK BOY ÜNİVERSAL ÜTÜ PRESİ
PNEUMATIC SCISSOR SYSTEM SEMI AUTOMATIC MEDIUM SIZE / LARGE SIZE IRONING PRESS.
УНИВЕРСАЛЬНЫЙ ПНЕВМАТИК ГЛАЖЕНЫЙ ПРЕСС С НОЖНИЦОМ СИСТЕМОМ ПОЛУАВТОМАТИЧЕСКОМ СРЕДНИМ РАЗМЕРОМ



CP1 / CP2

MANUEL SİSTEM BUHAR ISITMALI, PARLAK ÜST ÇENELİ, ORTA BOY / BÜYÜK BOY ÇAMAŞIRHANE PRESİ
MANUAL SYSTEM, MEDIUM SIZE / LARGE SIZE STEAM HEATED, SHINEY UPPER BUCK LAUNDRY PRESS
Ручной пресс для прачечной среднего размера с подогревом пара и верхней полирующей подушкой



CPP1 / CPP2

PNÖMATİK, MAKASLI SİSTEM, YARI OTOMATİK, PARLAK ÜST ÇENELİ, ORTA BOY / BÜYÜK BOY ÇAMAŞIRHANE PRESİ
PNEUMATIC, SCISSORS SYSTEM, SEMI-AUTOMATIC MEDIUM SIZE / LARGE SIZE SHINEY UPPER BUCK LAUNDRY PRESS
Полуавтоматический пневматический гладильный пресс (система ножниц), среднего размера



CPP6

PNÖMATİK SİSTEM ÜNİVERSAL ÇAMAŞIRHANE PRESİ
PNEUMATIC SYSTEM UNIVERSAL LAUNDRY PRESS
Пневматический универсальный пресс для прачечной



UP2DP

MANUEL SİSTEM DERİ ÜTÜ PRESİ
MANUAL SYSTEM IRONING PRESS FOR LEATHER
МЕХАНИЧЕСКИЙ ПРЕСС ДЛЯ ГЛАЖЕНИЯ КОЖИ



UPP2DP

PNÖMATİK, MAKASLI SİSTEM DERİ ÜTÜ PRESİ
PNEUMATIC SCISSORS SYSTEM IRONING PRESS FOR LEATHER
ПНЕВМАТИЧЕСКИЙ ПРЕСС ДЛЯ ГЛАЖЕНИЯ КОЖИ



UPD

MANUEL SİSTEM KÜÇÜK BOY DERİ ÜTÜ PRESİ
MANUAL SYSTEM, MINI SIZE IRONING PRESS FOR LEATHER
МЕХАНИЧЕСКИЙ ПРЕСС ДЛЯ ГЛАЖЕНИЯ КОЖИ (МИНИ)



BOSDV

PNÖMATİK, DİK SİSTEM VAKUMLU GÖMLEK BOS ÜTÜ PRESİ
PNEUMATIC VERTICAL SYSTEM SIRT SEAM OPENING IRONING PRESS WITH VACUUM
Пневматический пресс вертикальной системы для разутюжки швов рубашки с вакуумом



BOSPV

PNÖMATİK MAKASLI SİSTEM VAKUMLU GÖMLEK BOS ÜTÜ PRESİ
PNEUMATIC SCISSORS SYSTEM SHIRT SEAM OPENING IRONING PRESS WITH VACUUM
Пневматический пресс для разутюжки швов рубашки (система ножниц) с вакуумом



GYBPV

VAKUMLU, GÖMLEK YAN BASMA PRESİ (PNÖMATİK)
SHIRT SIDE PRESSING PRESS WITH VACUUM (PNEUMATIC)
Песс для глажки боковин рубашки с вакуумом (Пневматический)



GYMPDV

PNÖMATİK, DİK SİSTEM VAKUMLU GÖMLEK YAKA VE MANŞET ÜTÜ PRESİ
PNEUMATIC, VERTICAL SYSTEM WITH VACUUM SHIRT COLLAR AND CUFFS IRONING PRESS
ПНЕВМАТИЧЕСКИЙ ВЕРТИКАЛЬНЫЙ ПРЕСС С ВАКУУМОМ ДЛЯ ВОРОТНИК И МАНЖЕТЫ



GYMPV

PNÖMATİK, MAKASLI SİSTEM VAKUMLU GÖMLEK YAKA VE MANŞET ÜTÜ PRESİ
PNEUMATIC, SCISSORS SYSTEM WITH VACUUM SHIRT COLLAR AND CUFFS IRONING PRESS
ПНЕВМАТИЧЕСКИЙ ПРЕСС ДЛЯ ВОРОТНИК И МАНЖЕТЫ



GYM

MANUEL SİSTEM, GÖMLEK YAKA VE MANŞET ÜTÜ PRESİ
MANUAL SYSTEM, SHIRT COLLAR AND CUFFS IRONING PRESS
МЕХАНИЧЕСКИЙ ПРЕСС ДЛЯ ВОРОТНИК И МАНЖЕТЫ



GUR01

PNÖMATİK GÖMLEK ÜTÜ ROBOTU
PNEUMATIC SHIRT IRONING ROBOT
ПНЕВМАТИЧЕСКИЙ ПРЕСС ДЛЯ СОРОЧЕК

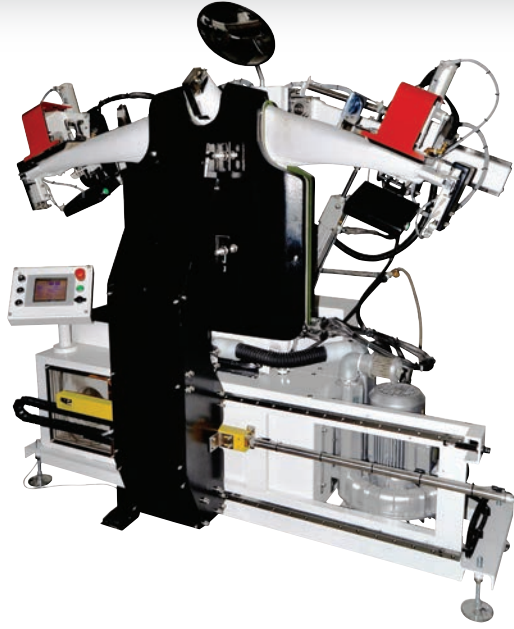

MERKEZİ SİSTEM OMUZ ÜTÜ TEZGAHI

CENTRAL SYSTEM SHOULDER IRONING PRESS
ЦЕНТРАЛИЗОВАННОЕ МАШИНА ДЛЯ РАЗУТОЖИВАНИЯ
ПЛЕЧО

UP4



UP4A



GYBZ

**MERKEZİ SİSTEM, ÇİFT APARATLI, BİR ÜTÜLÜ GÖMLEK YAN
ÜTÜ TEZGAHI**
CENTRAL SYSTEM, DOUBLE APPARATUS, ONE IRONED SHIRT
SIDE IRONING BENCH
ЦЕНТРАЛЬНАЯ СИСТЕМА, ДВОЙНОЙ
АППАРАТ, ОДНА ГЛАДИЛЬНАЯ
СКАМЬЯ ДЛЯ РУБАШКИ



UP109GZ

MERKEZİ SİSTEM, GÖMLEK ROBA ÜTÜ TEZGAHI
CENTRAL SYSTEM, SHIRT ROBA IRONING BENCH
ЦЕНТРАЛЬНАЯ СИСТЕМА, ГЛАДИЛЬНАЯ
СКАМЬЯ ДЛЯ РУБАШКИ ROBA



TOZ1

TOZ ALMA VE ÇEVİRME MAKİNASI (BACALI)
DUSTING AND TURNING OUT MACHINE WITH CHIMNEY
УСТРОЙСТВО ДЛЯ ВЫВОРАЧИВАНИЯ И ПЫЛЬ СОРОЧЕК



MPMA

**AYAKLI MODEL POŞETLEME
MAKİNASI**
POLLYBAGGER WITH
STAND
УПАКОВКА С
ПОДСТАВКОЙ



MPMD

POŞETLEME MAKİNASI DUVAR TİPİ
POLLYBAGGER, WALL- MOUNTED
УПАКОВКА НАСТЕННЫЙ

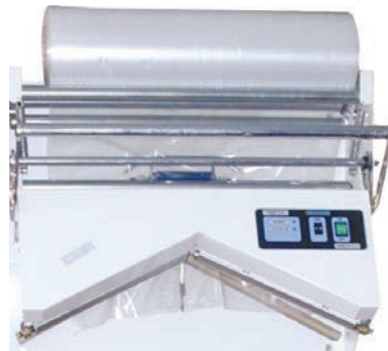

MPMK

**ALTAN KAYNAKLI,
KONFEKSİYON TİPİ
POŞETLEME MAKİNESİ**
BOTTOM WELDED,
APPAREL TYPE BAGING
MACHINE
СВАРОЧНАЯ МАШИНА
ДЛЯ ОДЕЖДЫ



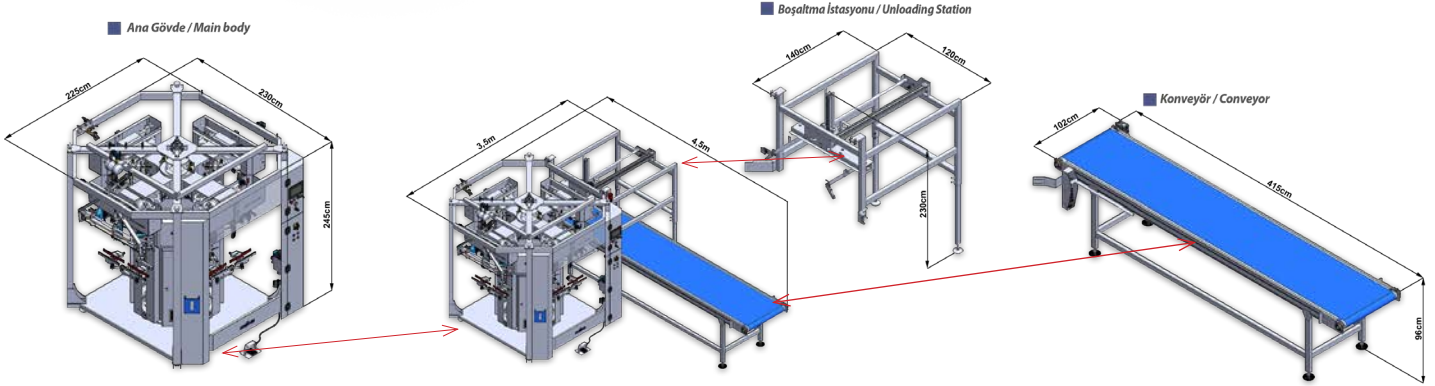

PSUR4 FULL OTOMATİK 4 İSTASYONLU DÖNER TABLALI PANTOLON ŞİŞİRME ÜTÜ ROBOTU

- Spor, Denim ve Casual pantolonların hızlı ve etkin son ütülemesi için otomasyon çözümü.
- Bir eleman ile dakikada 6 adet, günde 3.500 adet ütüleme kapasitesi ile verimlilikte zirve noktası.
- Plc kontrollü dokunmatik ekran kumanda paneli.
- Yükleme, buhar verme, şişirme, ve otomatik boşaltmadan oluşan 4 istasyon.
- Ön ceplere ve patlet kısmına ilave kalıp baskısı ve buhar ile ekstra ütüleme.
- Ütülenmiş pantolonların konveyör banda dizme ve istenen adette istifleme.
- Operatör için ergonomik çalışma imkanı sağlayan ürün dizaynı.
- Bel kısmında yumuşak ve likralı kumaşlar için bel rahatlatma fonksiyonu.
- Bel ve boy kısmında mekanik kilitli pistonlar ile ütüleme sırasında ölçüler sabit kalır; ilk ayarlanan ölçüler buhar ve şişirme istasyonlarında aynı şekilde sabitlenmiş olur.
- Formlu bel aparatları ile pantolonun bel ve basen kısmı tam doldurularak istenen formda ütüleme gerçekleşir.
- 50 yıllık MALKAN tecrübesi ve güvencesi ile %100 yerli üretim.

PSUR4 FULLY AUTOMATIC 4-STATIONS ROTARY TABLE TROUSER INFLATION IRONING ROBOT

- Automation solution for fast and effective finishing of sports, denim and casual trousers.
- The best in efficiency with a capacity of 6 pieces per minute and 3,500 pieces per day with one employee
- Plc controlled touch screen control panel.
- 4 stations consisting of loading, steaming, inflating and automatic unloading.
- Extra ironing with additional mold pressure and steam on front pockets and fly.
- Arranging the ironed trousers on the conveyor belt and stacking in the desired quantity.
- Product design providing ergonomic working opportunity for the operator.
- Waist loosening function for soft and lycra fabrics in the waist.
- With mechanically locked pistons in the waist and length part, the dimensions remain constant during ironing. First set dimensions It is fixed at the steam and inflation stations in the same way.
- 100% local production with 50 years of MALKAN experience and assurance.

PSURB

PNÖMATİK, MİKROİŞLEMCİLİ ROBOT PANTOLON ŞİŞİRME ÜTÜSÜ
PNEUMATIC TROUSERS TOPPER WITH MICROPROCESSOR
ПНЕВМАТИЧЕСКИЙ ТОППЕР С МИКРОПРОЦЕССОРОМ



PSUR

PNÖMATİK, ROBOT PANTOLON ŞİŞİRME ÜTÜSÜ
PNEUMATIC TROUSERS TOPPER
ПНЕВМАТИЧЕСКИЙ ТОППЕР



PSU1

YATIK TİP PANTOLON ŞİŞİRME ÜTÜSÜ
HORIZONTAL TYPE TROUSERS TOPPER
ХОРИЗОНТАЛЬНЫЙ ТОППЕР



MSUR

PNÖMATİK MANKEN ŞİŞİRME ÜTÜ ROBOTU
PNEUMATIC MANNEQUIN TOPPER
ПНЕВМАТИЧЕСКИЙ ПАРОМАНЕКЕН



MSU1K

KENDİNDEN KAZANLI MANKEN ŞİŞİRME ÜTÜSÜ
MANNEQUIN TOPPER WITH BUILT IN BOILER
Пароманекен со встроенным парогенератором



MSU1

MERKEZİ SİSTEM MANKEN ŞİŞİRME ÜTÜSÜ
CENTRAL SYSTEM MANNEQUIN TOPPER
ЦЕНТРАЛИЗОВАННЫЕ ПАРОМАНЕКЕН



MSURC02

PNÖMATİK CEKET PALTO ÜTÜ ROBOTU
PNEUMATIC JACKET IRONING ROBOT
пневматический пресс куртка робот



MSURT

PNÖMATİK MANKEN ŞİŞİRME ÜTÜ ROBOTU
PNEUMATIC MANNEQUIN TOPPER
ЖЕЛЕЗНЫЙ РОБОТ ТИШОРТ ТИШОРТ



MSURG

PNÖMATİK GÖMLEK ŞİŞİRME ÜTÜ ROBOTU
PNEUMATIC SHIRT TOPPER
ПНЕВМАТИЧЕСКИЙ ПАРОМАНЕКЕН ДЛЯ СОРОЧЕК





PEC2
PANTOLON PAÇA VE ETEK ÇEVİRME MAKİNASI
TROUSERS CUFF TURNING MACHINE
ШТАНИНА РАСКУРУТКА МАШИНА ЗА ПАНТОЛОН

EKOMSU2A

**EKONOMİK MODEL, OTOMATİK
DOLDURMALI MONT RODEO İŞLEME
MAKİNASI**

ECONOMIC MODEL OVERCOAT RODEO
FINISHING MACHINE WITH AUTO AIR
FEEDING

ЭКОНОМИЧЕСКИЙ МОДЕЛ РОДЕО
ФИНИШНАЯ
МАШИНА ДЛЯ ПИДЖАКИ,
АВТОМАТИЧЕСКИЙ ЗАПОЛНЕНИЕМ
ВОЗДУХ



EKOPSU2

**EKONOMİK MODEL, YATIK TİP RODEO
İŞLEME MAKİNASI**

ECONOMIC MODEL HORIZONTAL TYPE
RODEO FINISHING MACHINE

ЭКОНОМИЧЕСКИЙ ГОРИЗОНТАЛЬНЫЙ
РОДЕО ФИНИШНАЯ МАШИНА



EKOPSU3A

**EKONOMİK MODEL,
DİK SİSTEM OTOMATİK
DOLDURMALI PANTOLON
RODEO MAKİNASI**

ECONOMIC MODEL,
VERTICAL SYSTEM
RODEO FINISHING
MACHINE WITH AUTO AIR
FEEDING

ЭКОНОМИЧЕСКИЙ,
ВЕРТИКАЛЬНЫЙ РОДЕО
ФИНИШНАЯ МАШИНА
АВТОМАТИЧЕСКИЙ
ЗАПОЛНЕНИЕМ ВОЗДУХ



MSU4

**TAVAN ASMALI
MONT RODEO
İŞLEME MAKİNASI**

CEILING MOUNTED
OVERCOAT RODEO
FINISHING MACHINE

ПОТОЛОЧНЫЙ
РОДЕО ФИНИШНАЯ
МАШИНА ДЛЯ
ПИДЖАКИ



UPP30

PNÖMATİK, MAKASLI SİSTEM PANTOLON KIRIŞTIRMA PRESİ
PNEUMATIC SCISSORS SYSTEM TROUSERS WRINKLE PRESS

ПНЕВМАТИЧЕСКИЙ ПРЕСС ДЛЯ БРЮК МОРШИН

UPP31

PNÖMATİK, ÇİFT ALT KALIPLI, PANTOLON PAÇA KIRIŞTIRMA PRESİ
PNEUMATIC TROUSERS LEG WRINKLE PRESS WITH DOUBLE LOWER BUCKS

ПНЕВМАТИЧЕСКИЙ ПРЕСС ДЛЯ БРЮЧИН МОРШИН



UPP352

**PNÖMATİK, YATIK SİSTEM PANTOLON PAÇA VE KEMER
KIRIŞTIRMA PRESİ (ÇİFT APARATLI)**

PNEUMATIC HORIZONTAL SYSTEM TROUSERSLEG AND
WAISTBAND WRINKLE PRESS WITH DOUBLE APPARATUS

ПНЕВМАТИЧЕСКАЯ И ГОРИЗОНТАЛЬНОГО ПРЕСС ДЛЯ ВЕРХНЯЯ
ЧАСТ БРЮК И БРЮЧИН МОРШИН (С ДВОЙНОЙ АППАРАТОМ)



UPP36

PNÖMATİK, DİK SİSTEM, PANTOLON KIRIŞTIRMA PRESİ (İKİ ÜNİTE)
PNEUMATIC, VERTICAL SYSTEM TROUSERS WRINKLE PRESS
(TWO UNITS)

ПНЕВМАТИЧЕСКИЙ И ВЕРТИКАЛЬНЫЙ ПРЕСС ДЛЯ БРЮК
МОРШИН (С ДВОЙНОЙ СТАНЦИИ)



FIRÇA TAKIMI

BRUSH SET FOR RODEO FINISHING MACHINE
КОМПЕКТ ЩЕТОК ДЛЯ ФИНИШНАЯ МАШИНА

BALANSER

BALANCER
БАЛАНСЕР

BOYA KİMYASAL TABANCASI

PAINT CHEMICALS GUN
ПИСТОЛЕТ ДЛЯ ХИМИЧЕСКИЙ
КРАСКИ

SİLİKON KAUCUK

SILICON RUBBER
СЛИКОНОВОЙ РЕЗИНЫ



MTYP1 / MTYP2 / MTYP3
MANUEL SİSTEM TELA YAPIŞTIRMA PRESİ
55X115 CM / 70X115 CM / 60X130 CM
MANUAL SYSTEM FUSING PRESS
55X115 CM / 70X115 CM / 60X130 CM
РУЧНОЙ ДУБЛИРОВОЧНЫЙ ПРЕСС
55X115 CM / 70X115 CM / 60X130 CM



MTYP1P / MTYP2P / MTYP3P
PNÖMATİK MAKASLI SİSTEM ARABALI TELA YAPIŞTIRMA PRESİ
55 X 115 CM / 70 X 115 CM / 60 X 130 CM
PNEUMATIC / SCISSORS SYSTEM FUSING PRESS
55 X 115 CM / 70 X 115 CM / 60 X 130 CM
ПНЕВМАТИЧЕСКИЙ, ПРОХОДНОЙ ДУБЛИРОВОЧНЫЙ ПРЕСС
55 X 115 CM / 70 X 115 CM / 60 X 130 CM



MTYP1DP / MTYP2DP / MTYP3DP

PNÖMATİK DIK SİSTEM ARABALI TELA YAPIŞTIRMA PRESİ
55X115 CM / 70X115 CM / 60 X 130 CM
PNEUMATIC VERTICAL SYSTEM FUSING PRESS
55X115 CM / 70X115 CM / 60 X 130 CM
ПНЕВМАТИЧЕСКИЙ ВЕРТИКАЛЬНЫЙ ДУБЛИРОВОЧНЫЙ ПРЕСС
55X115 CM / 70X115 CM / 60 X 130 CM



ÇİFT BASKI SİSTEMİ - OPSİYONEL
DOUBLE PRESSING SYSTEM - OPTIONAL
ДУВХ СИЛИНДРИНХ СИСТЕМ



MKTP400 / MKTP600M
PNÖMATİK SİLİNDİR SİSTEM TELA YAPIŞTIRMA PRESİ 400 MM / 600 MM
PNEUMATIC ROLLER SYSTEM FUSING PRESS 400 MM / 600 MM
КОМПАКТНЫЙ ПРОХОДНОЙ ДУБЛИРОВОЧНЫЙ ПРЕСС 400 MM / 600 MM

MKTP 600/800/1000/1200/1600/1800
PNÖMATİK SİLİNDİR SİSTEM TELA YAPIŞTIRMA PRESİ
PNEUMATIC ROLLER SYSTEM FUSING PRESS
ПНЕВМАТИЧЕСКИЙ, ПРОХОДНОЙ ДУБЛИРОВОЧНЫЙ ПРЕСС

MTYP5
MANUEL SİSTEM TELA YAPIŞTIRMA VE TRANSFER BASKI PRESİ 55X80 CM
MANUAL SYSTEM FUSING AND TRANSFER PRINTING PRESS 55X80 CM
РУЧНОЙ ПРЕСС ТРАНСФЕРНЫЙ ДЛЯ ДУБЛИРОВАНИЯ И ТЕРМОПЕЧАТИ



MT7
KAPAKSIZ TELA ERİTME MAKİNASI 55X80 CM
FUSING MELT MACHINE WITHOUT COVER 55X80 CM
МАШИНА ФЬУЗИНГ РАСПЛАВА БЕЗ КРЫШКИ



DE0019
PASTAL ÜTÜSÜ
SPREADING IRON
РАСПРОСТРАНЕНИЕ УТЮГ



MT1

MANUEL SİSTEM YANA ÇEKME Lİ TRANSFER BASKI PRESİ 36X49 CM
MANUAL SYSTEM SLIDE-OPEN TRANSFER PRINTING PRESS 36X49 CM
РУЧНОЙ ПРЕСС ТРАНСФЕРНЫЙ ДЛЯ ТЕРМОПЕЧАТИ (ОТКРОЕТСЯ НА СТОРОНУ) 36 X 49 CM



MT1M

MANUEL SİSTEM, TRANSFER BASKI PRESİ 36X49 CM
MANUAL SYSTEM TRANSFER PRINTING PRESS 36X49 CM
РУЧНОЙ ПРЕСС ТРАНСФЕРНЫЙ ДЛЯ ТЕРМОПЕЧАТИ 36 X 49 CM



MT1K

MANUEL SİSTEM, KANALLI YANA ÇEKME Lİ TRANSFER BASKI PRESİ 36X49 CM
MANUAL SYSTEM SLIDE-OPEN TRANSFER PRINTING PRESS WITH CHANNELS 36X49 CM
РУЧНОЙ ПРЕСС ТРАНСФЕРНЫЙ С КАНАЛОМ ДЛЯ ТЕРМОПЕЧАТИ 36 X 49 CM



MT2A

55X115, 60X130, 70X115, 36X49, 55X80 cm)
PNÖMATİK YARI OTOMATİK TRANSFER BASKI PRESİ
PNEUMATIC SEMI-AUTOMATIC TRANSFER PRINTING PRESS
ПНЕВМАТИЧЕСКИЙ И ПОЛУАВТОМАТИЧЕСКИЙ ТРАНСФЕРНЫЙ ПРЕСС ДЛЯ ТЕРМОПЕЧАТИ 55 X 115 CM



MT1P

PNÖMATİK, MAKASLI SİSTEM TRANSFER BASKI PRESİ 36X49 CM
PNEUMATIC SCISSORS SYSTEM TRANSFER PRINTING PRESS 36X49 CM
ПНЕВМАТИЧЕСКИЙ ТРАНСФЕРНЫЙ ПРЕСС ДЛЯ ТЕРМОПЕЧАТИ 36 X 49 CM



MT2RK

PNÖMATİK, KENDİNDEN KAZANLI, ÇİFT ALT KALIPLI TRANSFER BASKI PRESİ (36X49, 50X60 cm)
 PNEUMATIC TRANSFER PRINTING PRESS WITH DOUBLE LOWER BUCKS AND BOILER
 ПНЕВМАТИЧЕСКИЙ ТРАНСФЕРНЫЙ ПРЕСС ДЛЯ ТЕРМОПЕЧАТИ С ДВОЙНОЙ СТАНЦИИ И С БОЙЛЕРОМ



MT2R

PNÖMATİK, ÇİFT ALT KALIPLI TRANSFER BASKI PRESİ 36X49, 50x60 CM
 PNEUMATIC TRANSFER PRINTING PRESS WITH DOUBLE LOWER BUCKS 36X49, 50x60 CM
 ПНЕВМАТИЧЕСКИЙ ТРАНСФЕРНЫЙ ПРЕСС ДЛЯ ТЕРМОПЕЧАТИ С ДВОЙНОЙ СТАНЦИИ 36X49, 50x60 CM



EKOMT2R

EKONOMİK MODEL, PNÖMATİK ÇİFT ALT KALIPLI TRANSFER BASKI PRESİ 36X49 CM
 ECONOMIC MODEL PNEUMATIC TRANSFER PRINTING PRESS WITH DOUBLE LOWER BUCKS
 ЭКОНОМИЧЕСКАЯ МОДЕЛЬ, ПНЕВМАТИЧЕСКИЙ ПЕЧАТНЫЙ ПРЕСС С ДВОЙНОЙ НИЖНОМ ТРАФАРЕТОМ



MT3P

PNÖMATİK, YARI OTOMATİK ÇİFT ALT KALIPLI TRANSFER BASKI PRESİ 15X15, 20x20 CM
 PNEUMATIC, SEMI-AUTOMATIC TRANSFER PRINTING PRESS WITH LOWER DOUBLE BUCKS
 15X15, 20x20 CM
 ПНЕВМАТИЧЕСКИЙ, ПОЛУАВТОМАИТЧЕСКИЙ ТРАНСФЕРНЫЙ ПРЕСС ДЛЯ ТЕРМОПЕЧАТИ С ДВОЙНОЙ СТАНЦИИ 15X15, 20x20 CM



MT6

MANUEL SİSTEM ŞAPKA TRANSFER BASKI PRESİ
 MANUAL SYSTEM HAT TRANSFER PRINTING PRESS
 РУЧНОЙ ПРЕСС ТРАНСФЕРНЫЙ ДЛЯ ТЕРМОПЕЧАТИ
 ДЛЯ ШАПКАХ



MT6P

PNÖMATİK ŞAPKA TRANSFER BASKI PRESİ
 PNEUMATIC HAT TRANSFER PRINTING PRESS
 ПНЕВМАТИЧЕСКИЙ, ТРАНСФЕРНЫЙ ПРЕСС
 ДЛЯ ТЕРМОПЕЧАТИ ДЛЯ ШАПКАХ



MTRU1

VAKUMLU, KENDİNDEN KAZANLI TRIKO ÜTÜ MAKİNASI
TRICOT IRONING TABLE WITH BOILER AND VACUUM
ГЛАДИЛЬНАЯ СТОЛ С ВАКУУМОМ, БОЙЛЕРОМ ДЛЯ ОТПАРИВАНИЯ ТРИКОТАЖА

**MTRU3**

MERKEZİ SİSTEM TRIKO ÜTÜ MAKİNASI
CENTRAL SYSTEM TRICOT IRONING MACHINE
ЦЕНТРАЛИЗОВАННЫЕ ГЛАДИЛЬНЫЕ СТОЛ ДЛЯ ОТПАРИВАНИЯ ТРИКОТАЖА

**MTRU2PVK**

PNÖMATİK, MAKASLI SİSTEM, KAPAKLI, KENDİNDEN KAZANLI, VAKUMLU TRIKO ÜTÜ PRESİ
PNEUMATIC, SCISSORS SYSTEM TRICOT IRONING PRESS WITH COVER AND BOILER
ПНОМАТИК НОЖНИЧА СИСТЕМА ПАКРИВАЕТСЬ БОЙЛЕР ВАКУУМ ТРИКОТАЖ ЖЕЛЕЗНИЙ

**MTRU2P**

PNÖMATİK MAKASLI SİSTEM KAPAKLI TRIKOÜTÜ PRESİ
PNEUMATIC, SCISSORS SYSTEM WITH COVER TRICOT PRESS
ПНОМАТИК НОЖНИЧА СИСТЕМА ЖЕЛЕЗНИЙ ИАКРИВАЕТСЬ ИЕРСС ТРИКОТАЖ

**PUM**

VAKUMLU, KENDİNDEN KAZANLI, İŞIKLI, BALANSERLİ, İKİ ÜTÜLÜ PERDE ÜTÜ MASASI
CURTAIN IRONING TABLE WITH VACUUM, BOILER, LIGHT BALANCER AND TWO HAND IRONS
ВАКУУМНИЙ, ПРЯМОУГОЛЬНЫЙ ГЛАДИЛЬНЫЙ СТОЛ ДЛЯ ГЛАЖЕНИЯ ШТОР

**MTRU2D**

PNÖMATİK, DİK SİSTEM, KAPAKLI, ARABALI TRIKO ÜTÜ PRESİ
PNEUMATIC VERTICAL SYSTEM TRICOT IRONING PRESS WITH COVER
ПНЕВМАТИЧЕСКИЙ, ВЕРТИКАЛЬНЫЙ, ПРОХОДНОЙ ПРЕСС ДЛЯ ТРИКОТАЖА



MTMD

KABİNLİ, ÇİFT VAKUMLU, IŞIKLI LEKE TEMİZLEME MAKİNASI
SPOT REMOVING MACHINE WITH CABIN, LIGHT AND DOUBLE VACUUM MOTORS
ПЯТНОВЫВОДНОЙ КАБИН С ДВУХ ВАКУМОМ И ОСВЕЩЕНИЕМ



MTMDK

KABİNLİ, ÇİFT VAKUMLU, IŞIKLI, KENDİNDEN KAZANLI LEKE TEMİZLEME MAKİNASI
SPOT REMOVING MACHINE WITH CABIN, BOILER, LIGHT AND DOUBLE VACUUM MOTORS
ПЯТНОВЫВОДНОЙ КАБИН С ДВУХ ВАКУМОМ, БОЙЛЕРОМ И ОСВЕЩЕНИЕМ



MTM

VAKUMLU, IŞIKLI LEKE TEMİZLEME MAKİNASI
SPOT REMOVING MACHINE WITH LIGHT AND VACUUM
ПЯТНОВЫВОДНОЙ СТОЛ С ВАКУМОМ И ОСВЕЩЕНИЕМ



MTMK

VAKUMLU, IŞIKLI, KENDİNDEN KAZANLI LEKE TEMİZLEME MAKİNASI
SPOT REMOVING MACHINE WITH BOILER, LIGHT AND VACUUM
ПЯТНОВЫВОДНОЙ СТОЛ С ВАКУМОМ, БОЙЛЕРОМ И ОСВЕЩЕНИЕМ



MT0002

ELEKTRİKLİ LEKE ÇIKARMA PİSTOLESİ
ELECTRICAL SPOT REMOVING PISTOL
ГРИЧЕСКИЙ ПИСТОЛЕТ ПЯТНОВЫВОДИТЕЛЬ



MT0003

SIVI ATMA PİSTOLESİ
SPOT REMOVING PISTOL WITH TWO INLETS
ПИСТОЛЬ ПЯТНОВЫВОДИТЕЛЬ



MT0005

ELEKTRİKLİ LEKE ÇIKARMA İLAÇ TABANCASI
ELECTRICAL SPOT REMOVING CHEMICAL GUN
ЭЛЕКТРИЧЕСКИЙ И ХИМИЧЕСКИЙ ПИСТОЛЕТ ПЯТНОВЫВОДИТЕЛЬ



UP110V

VAKUMLU, IŞIKLI, DAR TİP LEKE TEMİZLEME MAKİNESİ
NARROW TYPE SPOT REMOVING MACHINE WITH VACUUM AND LIGHT
ПЯТНОВЫВОДНОЙ СТОЛ С ВАКУМОМ И ОСВЕЩЕНИЕМ



UP110VK

VAKUMLU, IŞIKLI, KENDİNDEN KAZANLI, DAR TİP LEKE TEMİZLEME MAKİNASI
NARROW TYPE SPOT REMOVING MACHINE WITH BUILT IN BOILER, VACUUM AND LIGHT
ПЯТНОВЫВОДНОЙ СТОЛ С БОЙЛЕРОМ, ВАКУМОМ И ОСВЕЩЕНИЕМ



UP111

KOMBİNE, VAKUMLU, IŞIKLI, KENDİNDEN KAZANLI, LEKE TEMİZLEME VE ÜTÜ PASKALASI
COMBINED SPOT REMOVING AND IRONING BOARD WITH VACUUM, LIGHT AND BOILER
КОМБИНИРОВАННЫЙ, ВАКУУМНЫЙ, БОЙЛЕРНЫЙ С ОСВЕЩЕНИЕМ СТОЛ ЛДЯ ГЛАДЯ ПЯТНОВЫВЕДЕНИЕ



SAP2000

PNÖMATİK, MERKEZİ BUHARLI TEK İSTASYONLU ŞAPKA ÜTÜ PRESİ
PNEUMATIC HAT PRESS WITH CENTRAL STEAM AND SINGLE STATION
ПНЕВМАТИЧЕСКИЙ, ЦЕНТРАЛИЗОВАННЫЙ ПАРОВОЙ ПРЕСС ДЛЯ ШАПКИ

**SAP2002**

PNÖMATİK, MERKEZİ BUHARLI ÇİFT İSTASYONLU ŞAPKA ÜTÜ PRESİ
PNEUMATIC HAT PRESS WITH CENTRAL STEAM AND DOUBLE STATIONS
ПНЕВМАТИЧЕСКИЙ, ЦЕНТРАЛИЗОВАННЫЙ ПАРОВОЙ ПРЕСС ДЛЯ ШАПКИ С ДВУХ СТАНЦИИ

**SAP2000K**

PNÖMATİK, KENDİNDEN KAZANLI, TEK İSTASYONLU ŞAPKA ÜTÜ PRESİ
PNEUMATIC HAT PRESS WITH BOILER AND SINGLE STATION
ПНЕВМАТИЧЕСКИЙ, ПАРОВОЙ ПРЕСС С БОЙЛЕРОМ ДЛЯ ШАПКИ

**SAP2002K**

PNÖMATİK, KENDİNDEN KAZANLI, ÇİFT İSTASYONLU ŞAPKA ÜTÜ PRESİ
PNEUMATIC HAT PRESS WITH BOILER AND DOUBLE STATIONS
ПНЕВМАТИЧЕСКИЙ, ПАРОВОЙ ПРЕСС ДЛЯ ШАПКИ С БОЙЛЕРОМ И ДВУХ СТАНЦИИ



Malkan enerji tasarrufu paketi ile maliyetlerinizi aşağıya çekin

Artan hammadde, işçilik ulaşım fiyatları her geçen gün üretim maliyetlerinin yükselmesine ve satış fiyatlarının artmasına neden olmakta, bunun sonucunda da rekabet şansınız azalmaktadır.

Yeni geliştirdiğimiz RENERGY enerji tasarrufu sistemi

- Programlanabilir kontrol ünitesi
- Makinalara özel izolasyon
- Buhar kumanda birimi bölümlerinden oluşmaktadır.

Ütü preslerinde kullanılan tüm kalıplar çabuk ısınması için alüminyum alaşımı malzemeden imal edilmektedir. Kalıpların ısıtılması paslanmaz çelik borulu serpantin sistemi ile gerçekleştirilmektedir. Serpantin boruları kalıbın içine döküm işlemi sırasında yerleştirilerek kalıp ile olan ısıtma yüzeyi artırılmaktadır. Bu sayede ütüleme kalıpları çok daha kısa sürede ve daha az enerji ile ısıtılmaktadır.

Ütü makinelerinden yayılan aşırı ısı ortamın ısınmasına dolayısıyla çalışanların rahatsız olmasına verimin düşmesine neden olmaktadır. Bunu gidermek içinde soğutma sistemleri kullanılarak oluşan artık ısı dışarı atılmaktadır. Sonuç olarak oluşan artık ısı bu artık ısının işletme dışına atılması için kullanılan enerji üretim maliyetlerine yansımaktadır.

Malkan RENERGY sistemi ile ütü makinelerinin buhar tüketim yoğunluğu ve çalışma zamanlarına göre programlama yapılarak buharın kullanılmadığı veya az kullanıldığı zamanlarda tüketimi azaltılmıştır.

Yine aynı sistemde başlama zamanları programlanarak presin çalışma zamanına hazır hale getirmektedir.

Ütü presinin buharla temas eden tüm kısımları özel izolasyon malzemeleri ile kaplanarak dışarıya verilen ısı minimuma indirilmiştir.

RENERGY sistemi ile ütü makinelerinin buhar kullanımında %40'a kadar tasarruf sağlayabilir böylece üretim ortamına verilen artık ısıyı ve soğutma ihtiyacını azaltabilir bu sayede enerji tasarrufu sağlayabilirsiniz.

Decrease your costs by Malkan energy saving pocket.

Day by day increased raw material, labor and transportation charge increase the cost of production and sales price. Because of this, your competition chance will be low.

New improved RENERGY saving system includes below units:

- Programmable control unit
- Special isolation for machines
- Steam control unit

All bucks used on ironing presses are made of aluminium compound materials for being heated fast. Bucks're heated by serpentine system with stainless steel pipes. Serpentine pipes put inside buck during cast operation. Serpentine pipes get increased heated area. So that ironing bucks're heated in a short time and by less energy.

Working environment gets warm when ironing machines work. Heated environment effects workers badly so, productivity decreases. In order to prevent this bad effect, occurred much heat is thrown away by using cooling system. As a result, residual heat and energy for throwing it away reflects manufacturing costs.

When machine is turned on but doesn't do iron any cloth steam consumption of ironing machines is programmed By Malkan RENERGY system. In related to working time of machines steam consumption's decreased or completely finished by Malkan RENERGY system.

Also working time's programmed by this system and press gets ready on the programmed time.

Every part of ironing press that contacts with steam are covered by special isolation materials and discharged heat gets minimum.

Approximately % 40 energy's saved by RENERGY system. So cooling demand and discharged heat 's decreased.



Malkan makine 1971 yılından beri müşterilerimizin enerji ihtiyaçları karşılama için en son teknolojileri içeren hizmetler sunuyoruz.

İşletmeniz de enerji ve enerji nakil ihtiyaçlarını ve özellikle buhar kondens hava vakum konularında profesyonel ekibimizle en verimli çözümleri gerçekleştiriyoruz.

Mevcut buhar kazanınızın ve tesisatınızın işletme masrafları acaba sizin ihtiyaçlarınızdan daha mı fazla? Vakum ve basınçlı hava üretiminiz ihtiyacınızı karşılamıyor mu? Bu noktada yeni yapacağınız projeler, mevcut tesisatta verim artırıcı uygulamalar ve benzer konularda teknik danışmanlık hizmetini Malkan olarak ücretsiz sunmaktayız.

Uygulama olarak da beklenen optimum çözümü sağlayacak malzeme seçimi, kurulum, montaj izolasyon konularında günün son teknolojilerini de içeren her türlü hizmeti işletmenize uygun olarak sağlamaktayız.

Günümüzde enerji maliyetleri göz ardı edilmemesi gereken harcama kalemlerindedir. Verimsiz bir sistemde her geçen gün kaybettiğiniz para sizi rakiplerinizden bir adım daha geriye düşürebilir. Gereksiz enerji kayıplarının önüne geçebilmek için lütfen bizi arayın ve sorunlarınıza size özel çözümler bulalım. Teknik servisimizden yararlanın. Rakiplerinizden bir adım öne geçin.

As Malkan Machine company we've provided the services including latest technology in order to meet our customer energy needs since 1971.

For your demands of energy and energy transactions especially regarding steam, condense, air and vacuum we give the most productive solution by our professional team.

Are your current steam generator and working installation higher than your consumption?

Does not vacuum or produced air meet your demand?

We give technical consulting for new projects, productive implementations on current installation etc. free of charge as Malkan.

We provide to your company convenient service about material selection, installation, mounting, isolation including last trend technology for an optimum solution.

Nowadays energy is an important part of total expenses. It is not negligible. Money that lost everyday because of unproductive system can leave you behind your rivals.

Call us and give us chance to find special solution for unnecessary energy missing. Benefit from our technical consulting service. Be one step ahead of your rivals.



Makinelerimizde kullandığımız dokunma tik ekranlı paneller makine kullanıcı arası iletişimi olabildiğince basite indirgemıştır.

Program yazımı, program seçim, dil seçimi işlemlerini kullanıcı kısa sürede yapabilmektedir. PLC ekranları istenilen dillerde programlanabilmektedir.

Touch-screen type panel that we use at our machines makes interaction between machine and people very simple.

User can easily do programme, programme and language selection . PLC screens can be programmed according to required language.

eXP40-TTA/DC

7.0" TFT LCD ekran,	7.0" TFT LCD screen,
800X480 Piksel çözünürlük,	800X480 Pixels resolution
65K Renk çözünürlüğü,	65K Color resolution
20.000 Saat aydınlatma ömrü,	20,000 hours lighting life
24VDC Besleme,	24 V DC Supply
Win CE, Ethernet,	Win CE, Ethernet
Program kopyalama,	Programmed copy feature
12 farklı dil uygulanabilir,	12 different languages can be applied
Hata uyarıcı diagnostik özelliği,	Diagnostic feature of error stimulus
128 MB ram ile 100 farklı program,	With 128 MB RAM, 100 different programs
Ethernet bağlantısı ile uzaktan erişim,	Remote access via Ethernet connection
Türkçe ve İngilizce standart programlama dilleri,	Turkish and English standard programming languages
Ütölenen iş adetini sayma ve kaplama zaman uyarısı,	To count the number of work done and covering time warning
2 adet USB girişi ile masa üstüne program alma özelliği,	2 X USB input to receive the program on the main screen feature
Ekran üzerinden dijital olarak presleme basıncını ayarlama,	Digitally adjusting the pressing pressure on the screen
Makinelerin fonksiyonlarını ekranda manuel kontrol edebilme özelliği	The ability to manually control the functions of the machine on the screen

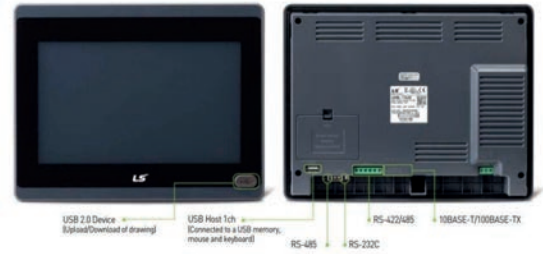

eXP60-TTA/DC

10.2" TFT LCD,	10.2" TFT LCD screen,
800x480 Piksel,	800X480 Pixels resolution
65K renk,	65K Color resolution
20.000 saat aydınlatma ömrü,	20,000 hours lighting life
24VDC Besleme,	24 V DC Supply
Win CE, Ethernet,	Win CE, Ethernet
Program kopyalama,	Programmed copy feature
12 farklı dil uygulanabilir,	12 different languages can be applied
Hata uyarıcı diagnostik özelliği,	Diagnostic feature of error stimulus
128 MB ram ile 100 farklı program,	With 128 MB RAM, 100 different programs
Ethernet bağlantısı ile uzaktan erişim,	Remote access via Ethernet connection
Türkçe ve İngilizce standart programlama dilleri,	Turkish and English standard programming languages
Ütölenen iş adetini sayma ve kaplama zaman uyarısı,	To count the number of work done and covering time warning
2 Adet USB girişi ile masa üstüne program alma özelliği,	2 X USB input to receive the program on the main screen feature
Ekran üzerinden dijital olarak presleme basıncını ayarlama,	Digitally adjusting the pressing pressure on the screen
Makinelerin fonksiyonlarını ekranda manuel kontrol edebilme özelliği	The ability to manually control the functions of the machine on the screen





MALKAN
(Mantar Saplı)
(Cork Handle)



JOLLY AVRUPA BUHARLI EL ÜTÖSÜ
JOLLY EUROPEAN HAND IRON WITH STEAM



TDC 03 (AVRUPA)
(Dijital)
(Digital)



SPEEDY Buharlı Fırçalı Ütü
Speedy Steam Brush



UP23YB Sanayi tipi büyük boy buharlı el ütüsüdür, 220 volt elektrik ile çalışır, saatte 4 kg. buhar harcar, termostat kumandalıdır. Rezistans gücü 800 W'ır. Ağaç saplıdır. Buhardan eli koruyan muhafazası vardır. a= 123, b=223 mm'dir, ağırlığı 2 kg'dır.

Industrial type large size hand iron, with wooden handle, needs 220 volt electricity, heated by thermostatic controlled heater. Heater power is 800 W. Sizes are a= 123; b= 223 mm weight= 2 kg.



APRIPIEGA Elektrikli avrupa sanayi tipi dikeş açma el ütüsüdür. 220 völd elektrik ile çalışır, saatte 4 kg buhar harcar, termostat kumandalıdır. Rezistans gücü 600 W'ır. Mantar saplıdır, terleme yapmaz. a= 50, b=180 mm, ağırlığı 1.3 kg'dır.

European industrial type seam opening hand iron with steam, needs 220 volt electricity heated by thermostatic controlled heater, with cork handle, prevents sweating. Sizes are a= 50, b=180 mm, weight= 1.3 kg.

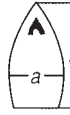

UP23YBA Sanayi tipi ağır taban buharlı el ütüsüdür, 220 Volt elektrik ile çalışır, saatte 4 kg. buhar harcar, termostat kumandalıdır. Rezistans gücü 800 W'ır. Ağaç saplıdır. Buhardan eli koruyan muhafazası vardır. a=123, b= 223 mm'dir, ağırlığı 3.6 kg'dır.

Industrial type heavy base hand iron, with wooden handle, needs 220 Volt electricity, heated by thermostatic controlled heater. Heater power is 800 W. Sizes are a=123, b=223 mm, weight = 2 kg



APRIPIEGA ALL STEAM direk buharlı avrupa sanayi tipi dikeş açma el ütüsüdür. Saatte 5 kg. buhar harcar, buhar ısıtmalı olup, buhar giriş ve çıkış teflon hortum ile bağlanır. Mantar saplıdır, terleme yapmaz. a= 50, b=190 mm, ağırlığı 1. kg'dır.

European industrial type seam opening hand iron with direct steam, heated by steam with cork handle prevents sweating. Steam inlet and outlet are connected with teflon hose. Sizes are a= 50, b=180 mm, weight 1kg.

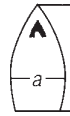

UP3ER Sanayi tipi elektrikli buharsız el ütüsüdür, 220 Volt elektrik ile çalışır, termostat kumandalıdır. Rezistans gücü 800 W'ır. Ağaç saplıdır. a=123, b= 223 mm'dir ağırlığı 2kg'dır.

Industrial type hand iron without steam, with wooden handle, needs 220 volt electricity, heated by thermostatic controlled heater. Heater power is 800 W. Sizes are a=123, b=223, weight= 2 kg.



ALL STEAM avrupa direk buharlı el ütüsüdür. Saatte 4 kg. buhar harcar, buhar ısıtmalı olup, buhar giriş ve çıkış teflon hortum ile bağlanır. Mantar saplıdır, terleme yapmaz. Ütünün tabanı ve gövdesi paslanmaz çelikdir. a=110, b= 198 mm, weight= 1.3 kg'dır.

European type hand iron with direct steam, heated by steam with cork handle, prevents sweating. Iron base and body made of stainless steel. Sizes are a = 110, b= 198 mm; weight= 1.3 kg.

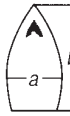

UP23ERA Sanayi Tipi elektrikli buharsız ağır taban el ütüsüdür. 220 Volt elektrik ile çalışır, termostat kumandalıdır. Rezistans gücü 800 W'ır. Ağaç saplıdır. a=123, b= 223 mm'dir, ağırlığı 4 kg'dır.

Industrial type heavy base hand iron without steam, with wooden handle, needs 220 volt electricity, heated by thermostatic controlled heater. Heater power is 800 W. Sizes are a=123, b= 223 mm; weight = 4 kg.



TDC 03 Avrupa buharlı el ütüsüdür. 220 volt elektrik ile çalışır, saatte 4 kg. buhar harcar, dijital göstergeli termostat kumandalıdır, termostat ünüün dışındadır. Rezistans gücü 800 W'ır. Mantar saplıdır, terleme yapmaz a= 100, b=200 mm, ağırlığı 1.90 kg'dır.

European hand iron with steam, needs 220 volt electricity, with cork handle, prevents sweating, with digital thermostate control. Sizes are a=100, b=200 mm, weight = 1.90 kg



Buharlı Fırça Ütüsü
Elbiseleri askıda buhar ile rötüs yaparak iz bırakmadan ve parlatmadan ütü yapar. 220 Volt elektrik ile çalışır. 3.5 - 4 bar buhar ile çalışır.

Steam Brush
High quality steam ironing for clothes on hanger, no shining, excellent finishing. needs 220 volt electricity works at 3.5 - 4 bar steam.

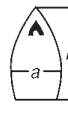

JOLLY Avrupa buharlı el ütüsüdür. 220 volt elektrik ile çalışır. saatte 4 kg buhar harcar, termostat kumandalıdır. Rezistans gücü=800W'ır Mantar Saplıdır, terleme yapmaz, buhardan eli koruyan muhafazası vardır. a=118, b= 200 mm'dir, ağırlığı 1.8 kg'dır.

European hand iron with steam, needs 220 volt electricity, with cork handle, prevents sweating. Sizes are a=118, b= 200 mm, weight=1.8 kg.



BSP200
ALLSTEAM DİREK BUHARLI EL ÜTÖSÜ (DAR TABAN)
ALLSTEAM DIRECT HAND IRON (NARROW BOTTOM)

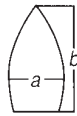

JOLLY ASTAR ÜTÖSÜ (Buharsız)
Sanayi tipi elektrikli buharsız el ütüsüdür.230 Volt elektrik ile çalışır. Termostat kumandalıdır. Rezistans gücü=800W'ır Mantar Saplıdır a=115; b=198 mm'dir. Ağırlığı = 1,800 kg'dır.

JOLLY LINING IRONING (No steam) Industrial type hand iron without steam, with wooden handle, needs 230 volt electricity, heated by thermostatic controlled heater. Heater power is 800 W. Sizes are a = 115; b=198mm; weight=1,800 kg'dır.



BSP300
ALLSTEAM DİREK BUHARLI EL ÜTÖSÜ (GENİŞ TABAN)
ALLSTEAM DIRECT HAND IRON (WIDE BOTTOM)

TEFLON ALTLIKLARI / TEFLON SOLES



Malkan teflon altlık
Malkan teflon sole



Alüminyum çerçeveli Avrupa teflon altlık
European theflone sole with aluminium frame



Alüminyum çerçeveli teflon altlık
Theflone sole with aluminium frame

KONDENSER GRUBU / CONDENSER GROUP



UPX1



UPX2

 <p>ES0147 PV1A SALYANGOZLU VAKUM MOTORU THRE ERPHASE VACUUM ENGINE ТРЕХФАЗНЫЙ ВАКУУМНЫЙ ЭЛЕКТРОДВИГАТЕЛЬ</p>	 <p>ES0153 PLASTIK FANLI VE SALYANGOZLU MOTOR 0,55KW VACUUM ENGINE 0,55W WITH PLASTIC FAN ВАКУУМНЫЙ ЭЛЕКТРОДВИГАТЕЛЬ МОЩНОСТЬЮ 0,55 ВТ С ПЛАСТИКОВЫМ ВЕНТИЛЯТОРОМ</p>	 <p>ES0205 25A PAKO ŞALTER 25A PAKO SWITCH 25A ПАКЕТНЫЙ ВЫКЛЮЧАТЕЛЬ</p>	 <p>ES0144 0,55 KW MONOFAZE SU MOTORU (AVRUPA) 0,55KW MONUPHASE WATER ENGINE (EUROPEAN) МОНОФАЗНЫЙ ВОДЯНОЙ ЭЛЕКТРОДВИГАТЕЛЬ МОЩНОСТЬЮ 0,55КВТ (ЕВРОПЕЙСКИЙ)</p>	 <p>ES0139 0,75 KW MONOFAZE SU MOTORU (LEO) 0,75W MONOPHASE WATER ENGINE (LEO) МОНОФАЗНЫЙ ВОДЯНОЙ ЭЛЕКТРОДВИГАТЕЛЬ МОЩНОСТЬЮ 0,75ВТ (LEO)</p>
 <p>ES0307 PASKALA TERMOSTATI 50-300°C IRONING BOARD RESISTANCE 50-300°C ГЛАДИЛЬНАЯ ДОСКА С УСТОЙЧИВОСТЬЮ К ВЫСОКОЙ ТЕМПЕРАТУРЕ 50-300°C</p>	 <p>ES0315 ISI TERMIĞİ 150°C HEAT THERMIC 150°C ТЕПЛОВОЙ НАГРЕВАТЕЛЬ 150°C</p>	 <p>ES0197 KAZAN IŞIKLI ANAMANTARI BOILER LIGHT TED SWITCH ПАРОВОЙ КОТЕЛ С ВЫКЛЮЧАТЕЛЕМ</p>	 <p>ES0217 PASKALA SIVICI (MOJEN) IRONING BOARD SWITCH (MOJEN) ПЕРЕКЛЮЧАТЕЛЬ ДЛЯ ГЛАДИЛЬНОЙ ДОСКИ (МОJЕН)</p>	 <p>ES0196 PROSESTAT BASINÇ ŞALTERİ PROSESTAT PRESSURE SWITCH МЕМБРАННЫЙ ПЕРЕКЛЮЧАТЕЛЬ ДАВЛЕНИЯ</p>
 <p>ES0195 BASINÇ ŞALTERİ (CEME 6 BAR) PRESSURE SWITCH (CEME 6 BAR) МЕМБРАННЫЙ ПЕРЕКЛЮЧАТЕЛЬ (CEME 6 BAR)</p>	 <p>ES0120 9A 220V AC KONTAKTÖR (LG, HYUNDAI) 9A 220V AC CONTACTOR (LG, HYUNDAI) ЗАМЫКАТЕЛЬ ПЕРЕМЕННОГО ТОКА 9А 220В (LG, HYUNDAI)</p>	 <p>ES0131 220V AC ZAMAN RÖLESİ (0-30 SN) 220V AC TIME RELAY (0-30SN) РЕЛЕ ВРЕМЕНИ ПЕРЕМЕННОГО ТОКА 220В (0-30СЕК)</p>	 <p>ES0321 EL ÜTÜ TERMOSTATI (YERLİ) HAND IRON RESISTANCE ТЕРМОСТАТ ДЛЯ РУЧНОГО УТЮГА</p>	 <p>ES0214 UNICA-LEVEL ŞAMANDIRA UNICA FLOAT ОПЛАВОК УРОВНЕМЕРА UNICA</p>  <p>ES0211 CEME ŞAMANDIRA CEME FLOAT ПОТЛЯВОК УРОВНЕМЕРА CEME</p>
 <p>ES0212 EL ÜTÜ SIVICI SWITCH FOR HAND IRON ВЫКЛЮЧАТЕЛЬ ДЛЯ УТЮГА</p>	 <p>EB0019 SU DEPOSU SEVİYE KARTI WATER TANK LEVEL CARD УРОВНЕМЕР ВОДЯНОГО БАКА</p>	 <p>EV0017 1/4" 220V 2Y KISICILI SELENOİD VALF CEME (BÜYÜK BOBİNLİ) 1/4" 220V 2Y PINTLE SELENOİD VALVE CEME (BIG COIL) СОЛЕНОИДНЫЙ КЛАПАН 1/4" 220 В (С МАЛЕНЬКОЙ КАТУШКОЙ)</p>	 <p>EV0018 1/4" 220V KISICILI SELENOİD VALF CEME (KÜÇÜK BOBİNLİ) 1/4" 220V PINTLE SELENOİD VALVE CEME (SMAL COIL) СОЛЕНОИДНЫЙ КЛАПАН 1/4" 220 В</p>	 <p>EV0025 3/4" 220V AC KAZAN SU SELENOİD VALFI 3/4" 220V AC BOILER WATER SELENOİD VALVE ВОДЯНОЙ СОЛЕНОИДНЫЙ КЛАПАН ДЛЯ ПАРОВОГО КОТЛА С ПЕРЕМЕННЫМ ТОКОМ 3/4" 220В АС</p>
 <p>DK0047 SÜNGERLİ MASA BEZİ TABLE CLOTH WITH SPONGE ГУБЧАТОЕ СУКНО ДЛЯ ГЛАДИЛЬНОГО СТОЛА</p>	 <p>DK0048 SÜNGERLİ PASKALA BEZİ BOARD CLOTH WITH SPONGE ГУБЧАТОЕ СУКНО ДЛЯ ГЛАДИЛЬНОГО СТОЛА</p>	 <p>DK0105 / DK0104 İTHAL MAVİ KÖPÜKLÜ SÜNGER IMPORT BLUE FOAMY SPONGE ИМПОРТНАЯ СИНЯЯ ГУБКА</p>	 <p>DK0094 / DK0095 KEÇE FELT ВОЙЛОК</p>	 <p>DK0125 İNCE ELEK TELİ THIN WIRE SCREEN ТОНКАЯ ПРОВОЛОЧНАЯ СЕТКА</p>
 <p>ER0028 10 KW 220V 2" KAZAN REZİSTANSI 10KW 220V 2" BOILER RESISTANCE ПАРОВОЙ КОТЕЛ СОПРОТИВЛЕНИЕМ 10КВТ 220В 2"</p>	 <p>ER0030 4,5 KW 220V 1-1/2" KAZAN REZİSTANSI 4,5KW 220V 1-1/2" BOILER RESISTANCE ПАРОВОЙ КОТЕЛ СОПРОТИВЛЕНИЕМ 4,5КВТ 220В1-1/2"</p>	 <p>ER0049 1,5 KW 220 V 100 CM PASKALA REZİSTANSI 1,5KW 220V 100CM BOARD RESISTANCE ГЛАДИЛЬНАЯ ДОСКА 100СМ СОПРОТИВЛЕНИЕМ 1,5КВТ 220В</p>	 <p>ER0017 EL ÜTÜ REZİSTANSI (DÖKÜM) HANDIRON RESISTANCE (CAST) РУЧНОЙ УТЮГ (CAST)</p>	 <p>EB0024 PLC EKİRAN XP30 BTEDC PLC SCREEN XP30 ЖИДКОКРИСТАЛЛИЧЕСКИЙ МОНИТОР XP30</p>
 <p>MD0018 KOL ÜTÜLEME YASTIĞI (SAC) ARM IRONING CUSHUON КОВРИК ДЛЯ РУЧНОГО УТЮГА</p>	 <p>MD0021 KOL ÜTÜLEME TAHTASI ARM IRONING WOOD ДЕРЕВЯННАЯ ДОСКА ДЛЯ РУЧНОГО УТЮГА</p>	 <p>MD0002 1/4" 0-6 BAR MANOMETRE (AYNALI) 1/4" 0-6 BAR MANOMETER 1/4" 0-6 BAR ДАТЧИК (МАНОМЕТЕР)</p>	 <p>ES0210 AVRUPA ELEKTRIKLI PEDAL EUROPEAN ELECTRIC PEDAL ЭЛЕКТРОПЕДАЛЬ ЕВРОПЕЙСКОГО КАЧЕСТВА</p>	 <p>MF0052 1/2" KÜRESEL VANA (KONSAN) 1/2" MODULAR VALVE 1/2" КАРСУСЕЛЬНЫЙ КЛАПАН</p>
 <p>PF0092 1/4" BASKI REGÜLATÖRÜ 1/4" PRESSURE REGULATOR 1/4" РЕГУЛЯТОР ДАВЛЕНИЯ</p>	 <p>MH0001 1/4" BEZ ÖRGÜLÜ DİREK BUHARLI EL ÜTÜ HORTUMU 1/4" DİREACT STEAM IRONING HOSE COVERED WITH CLOTH 1/4" ШЛАНГ ДЛЯ ПРЯМОЙ ПОДАЧИ ПАРА К УТЮГУ С ИЗОЛЯЦИОННЫМ ПОКРЫТИЕМ</p>	 <p>MH0067 5X11 MM ÖRGÜLÜ SİLİKON HORTUM 5X11MM BRAIDED SILIKON HOSE 5X11MM СИЛИКОНОВЫЙ ШЛАНГ В ОПЛЕТКЕ</p>	 <p>MH0057 3/4" 70 CM UNF19 ÇELİK TEL ÖRGÜLÜ SİRAL HORTUM 3/4" 70CM UNF 19 STEEL WIRE BRAIDED SPIRAL HOSE 3/4" 70СМ UNF 19 СПИРАЛЬНЫЙ ШЛАНГ В СТАЛЬНОЙ ПЛЕТКЕ</p>	 <p>DE0044 3X11M 250CM PRES FİŞLİ KABLO CABLE WITH PRESS PLUG КАБЕЛЬ С ПРЕССОЙ ФИШКОЙ</p>
 <p>MT0002 ELEKTRIKLI LEKE ÇIKARMA PİSTOLESİ SPOT REMOVING PISTOL WITH ELECTRIC ЭЛЕКТРИЧЕСКИЙ ПИСТОЛЕТ-ПЯТНОВЫВОДИТЕЛЬ</p>	 <p>MT0003 2 GİRİŞLİ SIVI ATMA PİSTOLESİ 2 INLET SPORT EJECTOR ПЯТНОВЫДУВАТЕЛЬ С 2 ОТВЕРСТИЯМИ</p>	 <p>MV0004 PRES ALT SİBONU (KOMPLE) PRESS LOWER PRESSURE RELIEF VALVE ЗАПОРНЫЙ КЛАПАН ДЛЯ ПОНИЖЕНИЯ ДАВЛЕНИЯ (В КОМПЛЕКТЕ)</p>	 <p>MF0007 1/2" KONDENSTOP TERMODYNAMİK CRNİ 1/2" CONDENSTOP THERMODYNAMIC CRNİ 1/2" ТЕРМОДИНАМИЧЕСКИЙ КОНТРИФКАТОР CRNİ</p>	 <p>DA0073 DUEFFE DİJİTAL ÜTÜ ELEKTRONİK KARTI DUEFFE DIGITAL IRON ELECTRONIC CARD ЦИФРОВАЯ ЭЛЕКТРОННАЯ КАРТА DUEFFE</p>

Referanslarımızdan bazıları

Some of our references



A.B.D.	KOSOVA	ALBANIA	LITVANIA
ALMANYA	KUVEYT	ALGERIA	MACEDONIA
ARJANTİN	LİBYA	ARGENTINA	MADAGASCAR
ARNAVUTLUK	LİTVANYA	AUSTRALIA	MALAYSIA
AVUSTRALYA	LÜBNAN	AUSTRIA	MALTA
AVUSTURYA	MACARİSTAN	AZERBEYCAN	MEXICO
AZERBEYCAN	MADAGASKAR	BAHREIN	MOLDOVA
B.A.E.	MAKEDONYA	BANGLADESH	MONGOLIA
BAHREYN	MALEZYA	BELARUS	MOROCCO
BANGLADEŞ	MALTA	BELGUIM	MYANMAR
BELARUS	MEKSİKA	BELIZE	NEW ZEALAND
BELÇİKA	MISIR	BOSNIA	NIGERIA
BELİZE	MOĞOLİSTAN	BRAZIL	NORWAY
BOSNA HERSEK	MOLDOVA	BULGARIA	PAKISTAN
BREZİLYA	MYANMAR	CHINA	PERU
BULGARİSTAN	NİJERYA	CROATIA	POLAND
CEZAYİR	NORVEÇ	CYPRIS	PORTUGAL
ÇİN	ÖZBEKİSTAN	EGYPT	QATAR
ENDONEZYA	PAKİSTAN	ENGLAND	ROMANIA
ERİTRE	PERU	ERITREA	RUSSIA
ESTONYA	POLONYA	ESTONIA	SAUDI ARABIA
ETİYOPYA	PORTEKİZ	ETHIOPIA	SCOTLAND
FAS	ROMANYA	FRANCE	SENEGAL
FRANSA	RUSYA	GEORGIA	SERBIA
GÜNEY AFRİKA	S.ARABİSTAN	GERMANY	SINGAPORE
GÜNEY KORE	SENEGAL	GREECE	SLOVAKIA
GÜRCİSTAN	SİRBİSTAN	HOLLAND	SLOVENIA
HOLLANDA	SİNGAPUR	HONG KONG	SOUTH AFRICA
HIRVATİSTAN	SLOVAKYA	HUNGARY	SOUTH KOREA
HİNDİSTAN	SLOVENYA	INDIA	SPAIN
HONG KONG	SRİLANKA	INDONESIA	SRI LANKA
IRAK	SUDAN	İRAN	SUDAN
İNGİLTERE	SURİYE	IRAQ	SYRIA
İRAN	TAYLAND	IRELAND	TAIWAN
İRLANDA	TAYVAN	ISRAEL	THAILAND
İSKOÇYA	TUNUS	ITALY	TUNISIA
İSPANYA	TÜRKMENİSTAN	JAPAN	TURKMENİSTAN
İSRAİL	UGANDA	JORDAN	U.A.E.
İTALYA	UKRAYNA	KAZAKİSTAN	U.S.A.
JAPONYA	ÜRDÜN	KOSOVA	UGANDA
KATAR	VİETNAM	KUWAIT	UKRAINE
KAZAKİSTAN	YEMEN	KYRGYZSTAN	UZBEKİSTAN
KIBRIS	YENİ ZELLANDA	LEBANON	VİETNAM
KIRGIZİSTAN	YUNANİSTAN	LIBYA	YEMEN

TSEK TÜRK STANDARLARI ENSTİTÜSÜ
KRİTERE UYGUNLUK BELGESİ
TURKISH STANDARDS INSTITUTION
CERTIFICATE OF CONFORMANCE TO CRITERIA

BELEGE NUMARASI REFERENCE NUMBER OF LICENSE: 022976-TSEK-0102
BELEGENİN İLK YERLİLİK TARİHİ DATE OF FIRST ISSUE OF LICENSE: 16.08.2021
BELEGENİN SON GEÇERLİLİK TARİHİ DATE OF THE END OF VALIDITY OF THE LICENSE: 22.03.2022
BELEGE SAHİBİ KURULUŞUN ADI NAME OF THE LICENSE HOLDER: MALKAN MAKİNA SANAYİ VE TİCARET ANONİM ŞİRKETİ
BELEGE SAHİBİ KURULUŞUN ADRESİ ADDRESS OF THE LICENSE HOLDER: KARAYOLLARI MAH. 599. SK. MALKAN MAKİNA NO:16/11 GAZİOSMANPAŞA İSTANBUL
ÜRETİM YERİ ADI NAME OF THE MANUFACTURING PLACE: MALKAN MAKİNA SANAYİ VE TİCARET ANONİM ŞİRKETİ
ÜRETİM YERİ ADRESİ ADDRESS OF THE MANUFACTURING PLACE: KARAYOLLARI MAH 599 SK. NO 27B GAZİOSMANPAŞA İSTANBUL
TESLİ YERİ ADRESİ ADDRESS OF THE MANUFACTURING PLACE: MALKAN
İLGİLİ BELEGELENDİRME KRİTERİ RELATED TURKISH STANDARD: İSO 9001:2015
BELEGE KAPSAMI SCOPE OF LICENSE: İZMİR İÇTİP ÜRETİM YERİ

22/03/2021
Belgeyi Onaylayan Marka Başvuru Adayı
AHMET NURİ KARTAL
TSE İSTANBUL BELEGELENDİRME MÜDÜRÜ V.

The holder of this certificate must ensure that the products and services covered by the certificate are in conformity with the criteria specified in the certificate. The holder must also ensure that the products and services covered by the certificate are in conformity with the criteria specified in the certificate. The holder must also ensure that the products and services covered by the certificate are in conformity with the criteria specified in the certificate.

TSE TÜRK STANDARLARI ENSTİTÜSÜ
TÜRK STANDARLARINA UYGUNLUK BELGESİ
TURKISH STANDARDS INSTITUTION
CERTIFICATE OF CONFORMITY TO TURKISH STANDARDS

BELEGE NUMARASI REFERENCE NUMBER OF LICENSE: 022976-TSE-0102
BELEGENİN İLK YERLİLİK TARİHİ DATE OF FIRST ISSUE OF LICENSE: 14.08.2021
BELEGENİN SON GEÇERLİLİK TARİHİ DATE OF THE END OF VALIDITY OF THE LICENSE: 12.04.2022
BELEGE SAHİBİ KURULUŞUN ADI NAME OF THE LICENSE HOLDER: MALKAN MAKİNA SANAYİ VE TİCARET ANONİM ŞİRKETİ
BELEGE SAHİBİ KURULUŞUN ADRESİ ADDRESS OF THE LICENSE HOLDER: KARAYOLLARI MAH. 599. SK. MALKAN MAKİNA NO:16/11 GAZİOSMANPAŞA İSTANBUL/TÜRKİYE
ÜRETİM YERİ ADI NAME OF THE MANUFACTURING PLACE: MALKAN MAKİNA SANAYİ VE TİCARET ANONİM ŞİRKETİ
ÜRETİM YERİ ADRESİ ADDRESS OF THE MANUFACTURING PLACE: KARAYOLLARI MAH 599 SK. NO 27B GAZİOSMANPAŞA İSTANBUL / TÜRKİYE
İPTAL EDİLEN BELEGE NUMARASI (Yeni) INDICATION OF REVOKED LICENSE (new): 004394 TSE-0101
TESLİ YERİ ADRESİ ADDRESS OF THE MANUFACTURING PLACE: MALKAN
İLGİLİ TÜRK STANDARTI RELATED TURKISH STANDARD: TS EN ISO 10472-6 / 21.02.2012
BELEGE KAPSAMI SCOPE OF LICENSE: ÇAMAŞIR YIKAMA TESİSLERİ, DİŞİ VE KURU YIKAMA SİSTEMLERİNE KULLANILAN ÜTÜLEME VE BAĞI İZMİR İÇTİP ÜRETİM YERİ

23.03.2021
Belgeyi Onaylayan Marka Başvuru Adayı
AHMET NURİ KARTAL
TSE İSTANBUL BELEGELENDİRME MÜDÜRÜ

The holder of this certificate must ensure that the products and services covered by the certificate are in conformity with the criteria specified in the certificate. The holder must also ensure that the products and services covered by the certificate are in conformity with the criteria specified in the certificate. The holder must also ensure that the products and services covered by the certificate are in conformity with the criteria specified in the certificate.

TSEK TÜRK STANDARLARI ENSTİTÜSÜ
KRİTERE UYGUNLUK BELGESİ
TURKISH STANDARDS INSTITUTION
CERTIFICATE OF CONFORMANCE TO CRITERIA

BELEGE NUMARASI REFERENCE NUMBER OF LICENSE: 022976-TSEK-0102
BELEGENİN İLK YERLİLİK TARİHİ DATE OF FIRST ISSUE OF LICENSE: 12.02.2022
BELEGENİN SON GEÇERLİLİK TARİHİ DATE OF THE END OF VALIDITY OF THE LICENSE: 23.04.2022
BELEGE SAHİBİ KURULUŞUN ADI NAME OF THE LICENSE HOLDER: MALKAN MAKİNA SANAYİ VE TİCARET ANONİM ŞİRKETİ
BELEGE SAHİBİ KURULUŞUN ADRESİ ADDRESS OF THE LICENSE HOLDER: KARAYOLLARI MAH. 599. SK. MALKAN MAKİNA NO:16/11 GAZİOSMANPAŞA İSTANBUL
ÜRETİM YERİ ADI NAME OF THE MANUFACTURING PLACE: MALKAN MAKİNA SANAYİ VE TİCARET ANONİM ŞİRKETİ
ÜRETİM YERİ ADRESİ ADDRESS OF THE MANUFACTURING PLACE: KARAYOLLARI MAH 599 SK. NO 27B GAZİOSMANPAŞA İSTANBUL
TESLİ YERİ ADRESİ ADDRESS OF THE MANUFACTURING PLACE: MALKAN
İLGİLİ BELEGELENDİRME KRİTERİ RELATED TURKISH STANDARD: ÜM-00-8K-003 / 24.08.2010
BELEGE KAPSAMI SCOPE OF LICENSE: -SARAY İÇTİP ÜRETİM YERİ

25/03/2021
Belgeyi Onaylayan Marka Başvuru Adayı
AHMET NURİ KARTAL
TSE İSTANBUL BELEGELENDİRME MÜDÜRÜ

The holder of this certificate must ensure that the products and services covered by the certificate are in conformity with the criteria specified in the certificate. The holder must also ensure that the products and services covered by the certificate are in conformity with the criteria specified in the certificate. The holder must also ensure that the products and services covered by the certificate are in conformity with the criteria specified in the certificate.

Inspecco SERTİFİKA

MALKAN MAKİNA SANAYİ VE TİCARET A.Ş.
KARAYOLLARI MAH. 599. SK. MALKAN MAKİNA NO:16/11 GAZİOSMANPAŞA / İSTANBUL / TÜRKİYE

ISO 9001:2015
Standartlara göre Kalite Yönetim Sistemi'nin uygulanışı

ENDÜSTRİYEL TİP ÜTÜ MAKİNELERİ, ÜTÜ PRESLERİ VE ÜTÜLERİN TASARIMI VE ÜRETİMİ, CNC TEZGAHLARI İLE FASON SAC İŞLEMELERİ

kapsamında, INSPECCO Zertifizierungs- und Inspektionsdienste GmbH tarafından değerlendirilmiştir olup onaylanmıştır.

Sertifika No: İNS.98-100-288
Sertifika Geçerlilik Adresi: 27.01.2021 / 28.01.2022
Sertifika Yayıncı ve Yeri: 27.01.2021, Plankstadt
Sertifika Revizyon No: 00
EA Kodu: 18

Genel Müdür: [Signature]

IAS ACCREDITED
MDS-117
ISO 9001:2015

Inspecco CERTIFICATE

This is to certify that the Management System of **MALKAN MAKİNA SANAYİ VE TİCARET A.Ş.**

KARAYOLLARI MAH. 599. SK. MALKAN MAKİNA NO:16/11 KAPİ NO:1 GAZİOSMANPAŞA / İSTANBUL / TÜRKİYE

has been assessed and approved by INSPECCO Zertifizierungs- und Inspektionsdienste GmbH against the following standard:

ISO 9001:2015
The Quality Management System is applicable to:

DESIGN AND MANUFACTURE OF INDUSTRIAL TYPES IRONING MACHINES, IRONING PRESSES AND IRONS METAL SHEET CUTTING BY USING OF LASER MACHINES (Exclusions: ...)

Certificate No: İNS.98-100-288
Certificate is valid from/dates: 27.01.2021 / 28.01.2022
Certificate issue date/ location: 27.01.2021, Plankstadt
Certificate revision No: 00
EA Code: 18

General Manager: [Signature]

IAS ACCREDITED
MDS-117
ISO 9001:2015

İSTANBUL SANAYİ ODASI YERLİ MALİ BELGESİ

Belgeyi Veriliş Tarihi : 18.09.2020 - Belgeyi Geçerlilik Tarihi : 18.09.2021 - Belge No : 202010834633

Özeti İçerik: MALKAN MAKİNA SANAYİ VE TİCARET ANONİM ŞİRKETİ

İçerik Adresi: Karayolları Mahallesi 599. Sokak No:27B GOSMANPAŞA İSTANBUL

Özellikler: Yerli Kimlik No: 611082651 TC Kimlik No: MERSİS No: 061108265100001

Telefon: 212-5380534 E-posta: kalite@malan.com.tr
Faks: 212-4779950 Web Adresi: www.malan.com.tr
Ticaret Sicil No: 269955 Dye Sicil No: 15882

Özet Adı: Palmetik İhtisat İşletmesi
Ürün Kodu (PRODCOMACTIVITY): 28.24.21.39.00 /
Tebliğ Durumu (Market Ad, Model, Seri Numarası, Class): Marka Adı: MALKAN
Kapsam Raporunun Tarihi: 05.10.2018 No: 30142 Geçerlilik Süresi: 15.10.2020
Sırası Sicil Belgesinin Tarihi: 06.03.2018 No: 711113

Yerli Katkı Oranı: % 62,67

Özellikler: Teknolojik Değer (diğer/orta-düşük/orta-yüksek/yüksek/Enamort) - orta-yüksek

Diğer bilgi ve belgeler:

Bu belge Bilim, Sanayi ve Teknoloji Bakanlığı'nın 13/09/2014 tarih ve 29118 sayılı Resmi Gazete'de yayımlanan "Yerli Mal Tebliği (SMD 2014/35)" ile belirlenen ve TOBB tarafından belirlenen "Yerli Mal Belgesinin Değerlendirilme Uygulanma" göre 18.09.2020 tarihinde değerlendirilmiştir. Belgeyi geçersiz kılan yeni veriliş belgesinden itibaren bir yıl geçerlidir.

İstanbul Sanayi Odası

EU IPO EUROPEAN UNION INTELLECTUAL PROPERTY OFFICE

Registered / Registrado 11/01/2017
No 015688153

EUROPEAN UNION INTELLECTUAL PROPERTY OFFICE CERTIFICATE OF REGISTRATION

This Certificate of Registration is hereby issued for the European Union trade mark identified below. The corresponding entries have been recorded in the Register of European Union trade marks.

OCINA DE PROPIEDAD INTELLECTUAL DE LA UNIÓN EUROPEA CERTIFICADO DE REGISTRO

Se expide el presente Certificado de Registro para la Marca de la Unión Europea que se identifica a continuación. Las menciones y las informaciones relativas a tal marca han sido inscritas en el Registro de Marcas de la Unión Europea.

malkan 1971

The Executive Director / El Director Ejecutivo
Antonio Campinos

TÜRK STANDARLARI ENSTİTÜSÜ TSE-HYD HİZMET YETERLİLİK BELGESİ

Belge No: 24-HYD-248
İlk Veriliş Tarihi: 22.04.1998
Son Geçerlilik Tarihi: 22.04.2022

Firmanın Adı: MALKAN MAKİNA SANAYİ VE TİCARET ANONİM ŞİRKETİ
Firmanın Adresi: KARAYOLLARI MAH. 599. SK. MALKAN MAKİNA NO:16/11 GAZİOSMANPAŞA İSTANBUL/TÜRKİYE
Hizmet Yeri Adresi: İZMİR'DE KARAYOLLARI MAH. 599. SK. NO:18 GAZİOSMANPAŞA İSTANBUL/TÜRKİYE
Sicil No: 269955

Verilen Hizmetin Kapsamı

1. TS 10889 (Sİ 04 2015) YETKİLİ SERİSİLER - ELEKTİRİK VE/VEYA GAZLA ÇALIŞAN SANAYİ TİPİ ÇIĞKALAN KLİMALARI STANDARTLARINA UYGUNLUK YERLİ YERLİLİK BELGESİ (Bİ GÜRLÜK ÜNİVERSİTESİ)

2. MALKAN MAKİNA SANAYİ VE TİCARET ANONİM ŞİRKETİ YETKİLİ SERİSİ (160229) (17.07.2018) İZMİR'DE ATILAN HANRAKALI

3. TS 12082 (Sİ 02 2014) YETKİLİ SERİSİLER - TEKSTİL VE KONFEKSİYON MAKİNELERİ İÇİN KLİMALAR STANDARTLARINA UYGUNLUK HİZMET YERLİLİK BELGESİ

4. MALKAN MAKİNA SANAYİ VE TİCARET ANONİM ŞİRKETİ YETKİLİ SERİSİ (160229) (17.07.2018) (MALKAN) MARKALI

www.tse.gov.tr

TEKNİK BİLGİLER

TECHNIC INFORMATION



MAKİNE ÇALIŞMA SİSTEMLERİ

Dik Sistem
Döner (Karusel) Sistem
Kızaklı Sistem
Asansörlü Sistem
Makaslı Dik Baskılı Sistem (Pnömatik)
Pnömatik Makaslı Sistem
Manuel Makaslı Sistem

MACHINE WORKING SYSTEMS

Vertical System
Carousel System
Linear System
Rotary System
Scissors – Vertical System (Pneumatic)
Pneumatic Scissors System
Manual Scissors System

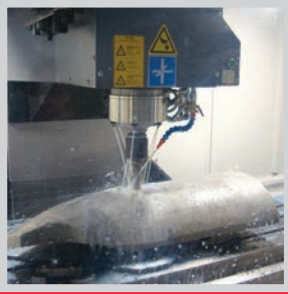

PRES KALIPLARI

Hassas Kalıp İşleme Teknolojisi (Cnc Dik İşlem Merkezi)
Serpantin Sistemi ile Hızlı Kalıp Isıtma ve Enerji Tasarrufu
Serpantin Sistemi ile Kızgın ve Kuru Buhar Çevre Vakum ile Kenar Buhar Emişi
Kalıpların her bölgesinden eşit buhar dağılımı

PRESS MOULDS

Sensitive mould processing technology (Cnc vertical process center)
Fast mould heating and energy saving by serpentine system
Hot and dry steam by serpentine system
Side vacuum suction by circumference vacuum
Equal steam distribution whole surface of buck



YÜKSEK KONTROL TEKNOLOJİSİ

PLC Lojik Kontrol
Dokunmatik Ekran ile Kolay Programlama
Dijital Mesafe Kontrolü
Dijital Basınç Kontrolü ve Aralama
Kademeli Buhar Kontrolü
Kademeli Vakum Kontrolü
Kademeli Hava Üfleme Kontrolü
Diagnostik (arıza tespit) özelliği

HIGH CONTROL TECHNOLOGY

Plc Logic Control
Easy programming by touching screen.
Digital Distance Control
Digital pressure control and making ajar
Progressive steam control
Progressive vacuum control
Progressive air blowing control
Diagnosis feature



GENEL ÖZELLİKLER

Birinci Sınıf Malzeme (Festo veya SMC Pnömatik Malzeme ile Donanım)
Profesyonel Kalıp Kaplama (Alman Malı Microlite veya Vomatex Marka Tel + Silikon+Keçe+Bez)
CE Normlarına Uygun Güvenlik Donanımı
Teknik Dökümantasyon
Elektrostatik Toz Boya
Satış sonrası hizmetler ve servis konusunda 1971'den gelen Malkan Güvencesi.

GENERAL FEATURE

First class material (festo or smc pneumatic material)
Professional mould covering (made in Germany microlite or vomatex brand wire+silicon+felt+fabric)
Safety equipment suitable ce norms
Technic Document
Electrostatic Power Dye
Malkan guarantee for after-sales and service since 1971



Dizayn Reklam
0212.567 28 29

* Malkan ürettiği makinelerdeki görsel fonksiyonel değişiklik hakkını saklı tutar.

* Bu kataloğtaki ürünlerin fikri mülkiyet hakkı Malkan Makina'ya aittir

* Malkan keeps hidden functional and visual changing right on its products.



Malkan Makina Sanayi ve Ticaret Anonim Şirketi

Merkez & Showroom / Head Office & Showroom
Küçükköy Karayolları Mah. 559 Sk. No: 16
Gaziosmanpaşa 34255 İstanbul / Türkiye
Tel : 90(212) 477 97 97 - 479 89 94 -95
Fax : 90(212) 477 99 50

Fabrika / Factory
Küçükköy Karayolları Mah. 559. Sk No: 27/B
Gaziosmanpaşa 34255 İstanbul / Türkiye
Tel : 90 (212) 538 05 34
Fax: 90(212) 538 12 23

Şube/ Branch Office
İMÇ. 2. Blok No: 2315
34470 Unkapanı - İstanbul / Türkiye
Tel : 90(212) 514 00 77-78
Fax : 90 (212) 513 12 43

Servis / Service
Küçükköy Karayolları Mah. 559 Sk. No: 16
Gaziosmanpaşa 34255 İstanbul / Türkiye
Tel : 90(212) 477 98 62
Fax : 90(212) 477 99 50